

Capacitive Position Sensors - Nanometrology Solutions -2007

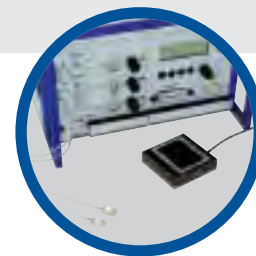

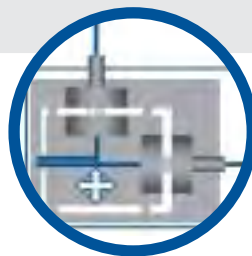
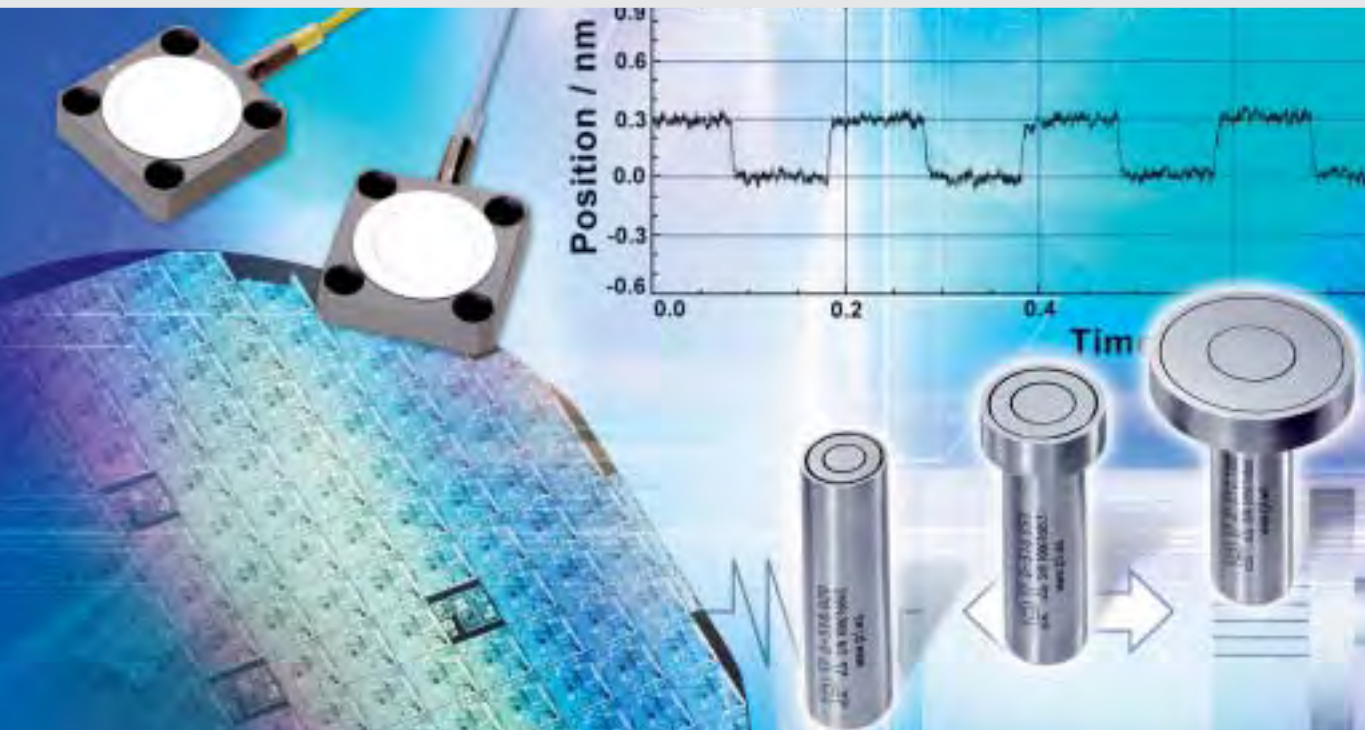

Piezo • Nano • Positioning

For the latest Information click

http://www.physikinstrumente.com/en/products/capacitive_sensor/

Nanometrology, Nanopositioning, NanoAutomation®

Ultra-Precision Measuring and Positioning Solutions for Industry and Research



PI headquarters. PI employs the world's most experienced R&D and production teams for nanopositioning systems.

Ultra Precision Technology – Years Ahead of its Time

PI has been a world market leader in nanopositioning technology for decades. In order to provide nanopositioning systems of the highest accuracy class, PI had to develop its own capacitive position sensing systems 15 years ago. Since then, tens of thousands of sensor and controller channels have been manufactured for use in PI's closed-loop piezo positioning stages and in custom nanomeasuring applications. This advanced measuring technology is now available in cost-effective, easy-to-use, stand-alone systems, featured in this brochure.

Key Technologies Under One Roof: A Plus for Our Customers

PI has a strategy of vertical integration with all key technologies developed and maintained in one company. This permits direct control over every step from conception to shipment, optimizing quality and cost. As a customer, you, too, can profit from our over 30 years experience in controlling and measuring motion at the nanometer level. PI can react quickly to development and production needs of OEM customers – even for highly complex custom products and assemblies.

Applications for Nanomeasuring and Nanopositioning Systems

Today PI delivers Nanopositioning & Nanometrology solutions for all important high-tech markets:

- Semiconductors
- Data Storage
- Photonics, Fiber Optics, Telecom
- Life Sciences
- Lasers, Optics, Microscopy
- Aerospace Engineering
- Precision Machining
- Astronomy

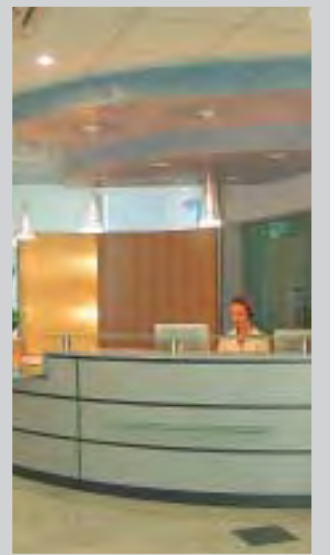

PI Ceramic, piezo ceramics factory



Capacitive Position Metrology

Overview

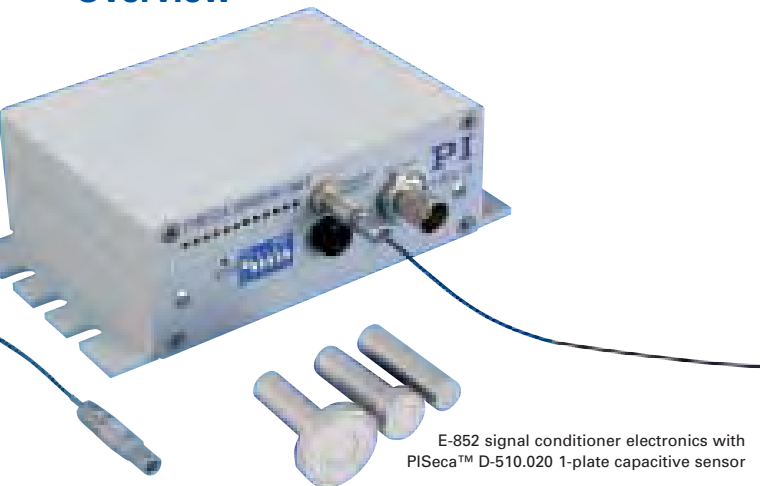

E-852 signal conditioner electronics with PISeca™ D-510.020 1-plate capacitive sensor

Properties of PI Sensors

- Measurement Ranges from 10 up to 500 μm and More
- Sub-Nanometer Position Resolution
- Non-Contact Absolute Measurement of Displacement / Motion / Vibration
- Immune to Wear and Tear
- Ideal for Multi-Axis Applications
- Improved Linearity with ILS Signal Electronics
- High Bandwidth up to 10 kHz
- Measures Position of the Moved Interface (Direct Metrology)
- High Temperature and Long-Term Stability ($<0.1 \text{ nm}/3 \text{ h}$)
- Vacuum Compatible
- Compact 1- and 2-Electrode Sensors, Custom Designs
- Guard-Ring Electrode Eliminates Boundary Effects
- Invar Versions for Highest Temperature Stability ($5 \times 10^{-6}/\text{K}$)

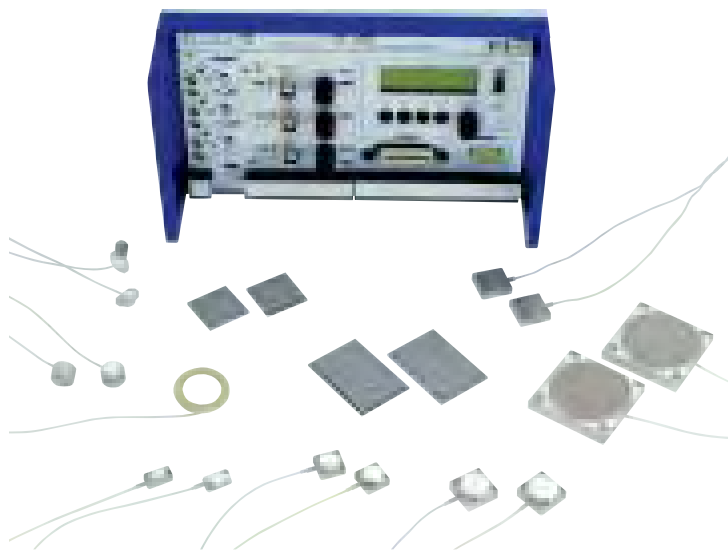

Standard D-015, D-050, D-100 2-plate sensors (front from left) and a selection of custom sensors

One- and Two-plate Sensors

Capacitive sensors perform non-contact measurements of geometric quantities representing distance, displacement, separation, position, length or other linear dimensions with sub-nanometer accuracy. PI offers capacitive sensors for the integration in user applications in two-plate-capacitor versions for highest performance and as PISeca™ single-electrode sensors, for more flexibility and easier integration.

Measurement Principle

The measurement principle in both cases is the same: two conductive surfaces set up a homogenous electric field; the change in displacement of the two plates is proportional to the signal conditioner output. Dual-plate sensors measure the distance between two well-defined sensor plates with carefully aligned surfaces which generate the most accurate electric field and hence provide optimal results. Single-plate capacitive sensors measure the capacitance against electrically conductive references, such as metallic plates, and are very convenient to install and connect.

Nanopositioning and Nanometrology

PI offers the widest range of high-dynamics and high-resolution nanopositioning systems worldwide. The precision and repeatability achieved would not be possible without highest-resolution measuring devices. Capacitive sensors are the metrology system of choice for the most demanding nanopositioning applications. The sensors and the equally important excitation and read-out electronics are developed and manufactured at PI by expert teams with longstanding experience.

Test and Calibration

PI's nanometrology calibration laboratories are seismically, electromagnetically and thermally isolated, and conform to modern international standards.

PI calibrates every capacitive measurement system individually, optimizing the performance for the customer's application. Such precision is the basis of all PI products, standard and customized, and assures optimum results in the most varied of applications.

Function, Properties, Advantages



D-100 (2 pairs), D-050 and D-015

Accuracy

Accuracy, linearity, resolution, stability and bandwidth are far better than with conventional nanometrology sensors like LVDT or strain gauge sensors.

Non-contact operation means no parasitic forces influencing the application and results in measurement free of friction and hysteresis.

Guard-Ring Design for Improved Linearity

Sensor design has a strong influence on linearity. The superior PI design uses a guard-ring electrode that eliminates sensor electrode boundary effects. This ensures a homogenous field in the measurement zone and results in higher measuring linearity.

Single- and Multi-Channel Electronics

PI's signal conditioner electronics are specially designed for

high bandwidth, linearity and ultra-low noise and are perfectly matched to the various PI sensor probes. PI offers signal conditioner electronics and controllers for one to three channels. The E-509 multi-channel modules plug into the modular E-500 / E-501 controller chassis. Bandwidth and measurement range can be factory-set to meet the specific needs of each application. The E-852 one-channel signal conditioner electronics for PISeca™ single-plate sensors are designed as stand-alone systems with user-selectable bandwidth and range setting and can be synchronized to operate in multi-channel applications.

Higher Linearity through ILS Electronics

All of PI's signal conditioning electronics are equipped with the PI proprietary ILS linearization circuit that minimizes non-parallelism errors.

Easy Handling and Integration

PISeca™ single-electrode sensors are particularly easy to install in a measurement system. On the single-channel electronics, an LED-bar indicates the optimum probe-to-target gap for the different measurement range settings. The multi-channel electronics come optionally with displays and/or a PC interface on a module in the same housing.

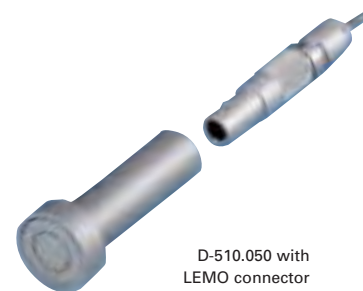

D-510.050 with LEMO connector for easy handling

Ideal for Closed-Loop Piezo Nanopositioning

Closed-loop nanopositioning systems may be controlled by sensor / servo-controller modules of PI's E-500 series. Such modules are available for connecting up to three position sensors, either stand-alone or integrated into the motion system. Closed-loop operation eliminates the drift and hysteresis that otherwise affect piezo actuators.

For nanopositioning tasks with the most stringent accuracy requirements PI offers high-end digital controllers.



The P-752.11C piezo nanopositioning system with integrated capacitive sensors provides position resolution down to 0.1 nm

Applications for Capacitive Position Sensors

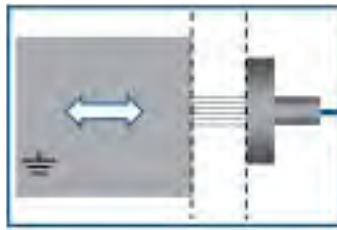

Measuring Displacement with Nanometer Precision

Capacitive displacement sensors measure the shortest of distances with highest reliability. The quantity measured is the change of capacitance between sensor plate and the target surface using a homogenous electric field. Accuracies in the sub-nanometer range are regularly achieved. Absolute measurement is possible with a well-adjusted, calibrated system.

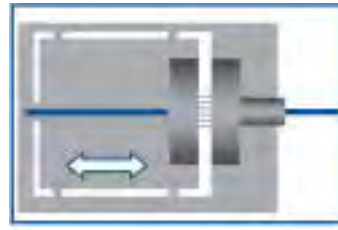

Nanopositioning / Closed-Loop Systems

One application of high-resolution displacement measurement is for nanopositioning. Two-plate capacitive sensors can measure distance, and hence position, of a moving object with excellent precision. The high sensor bandwidth allows closed-loop control in high-dynamics applications.

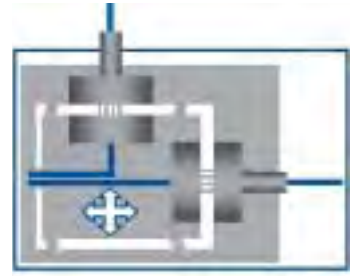

Parallel Metrology / High-Precision Multi-Axis Measurements

Closed-loop, multi-axis nanopositioning tasks are realized with high-performance positioners that make use of direct metrology and parallel kinematics. This allows measuring all degrees of freedom at the same time, which compensates guiding errors (Active Trajectory Control concept). Here, capacitance gauges are the most precise measuring systems available, and give the best position resolution results.



Measuring Straightness and Flatness / Active Cross-Talk Compensation

Excellent resolution in straightness and flatness measurements over long travel ranges is achieved with capacitive single electrode sensors. One application is measuring crosstalk in nanopositioning. Crosstalk, off-axis motion from one actuator in the motion direction of another, is detected immediately and actively compensated out by the servo-loops. The high sensor bandwidth provides excellent dynamic performance.



Out-of-Plane Measurement / Constant-Height Scans / Out-of-Round Measurement

Compensation of undulating and oscillating motion, e.g. in constant height scans or in white-light interferometry, are applications for which capacitive sensors are especially well suited.

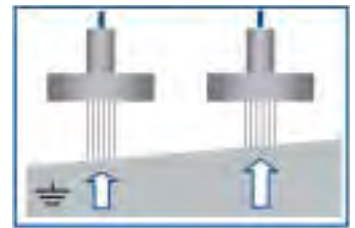

Tip / Tilt Measurement and Compensation

Integrating capacitive sensors in a system is a good way to measure tip/tilt motion precisely. The moved object's tip angle is measured differentially, and, if required, compensated out.

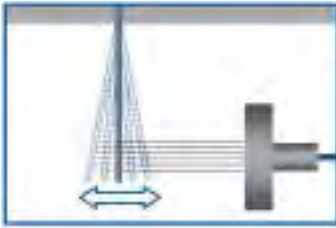

Vibration, Flatness, Thickness

The high dynamics of the PISeca™ capacitive gauge system even allows measurements of vibrations and oscillations with excellent resolution. Flatness of a rotating workpiece or differences in thickness in the nanometer range can be detected. One field of application is in the production of disk drives or in active compensation of vibration.

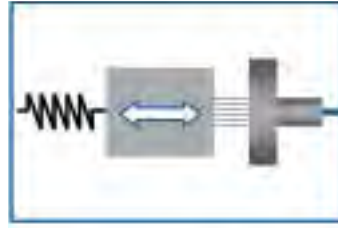

Force Sensors with Micronewton Sensitivity

Single-electrode capacitive sensors, which measure sub-nanometer displacement from a distance with no contact, are frequently used as high-resolution force sensors. In a system having suitably well-defined stiffness, the measured displacements translate to forces with resolutions in the micronewton range, all without influencing the process being measured.

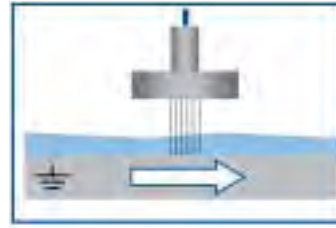

Layer Thickness with Sub-Micron Accuracy

Measuring the thickness of a film or layer of non-conducting material on a moving, conductive, surface (e.g. a rotating drum) is an ideal job for capacitive sensors due to their non-contact operation and their high dynamic performance.

For the latest Information click

http://www.physikinstrumente.com/en/products/capacitive_sensor/

Selection Guide

Capacitive Displacement Sensors – Selection Guide

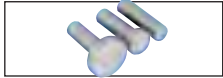

| Models* | Nominal Measurement Range [μm]* | Extended Measurement Range [μm]* | Material* | Notes |
|-----------|---------------------------------|----------------------------------|-----------|--|
| D-510.020 | 20 | to 100 | Steel | PISeca™ single-electrode capacitive sensor probes Sub-nanometer resolution and excellent linearity, easy setup, extended measurement ranges on request |
| D-510.050 | 50 | to 250 | Steel | |
| D-510.100 | 100 | to 500 | Steel | |
| D-015 | 15 | 45 | Aluminum | Capacitive 2-plate position sensors with sub-nanometer resolution, other materials on request |
| D-050 | 50 | 150 | Aluminum | |
| D-100 | 100 | 300 | Aluminum | |

*Custom dimensions, sensors, designs for volume buyers

Signal Conditioner Electronics / Controllers – Selection Guide



| Models* | Linearity | Resolution (% of full scale measurements range, @ max. bandwidth) | Max. Bandwidth (kHz) | Channels | Notes |
|-----------|-----------|---|----------------------|----------|---|
| E-852 | <0.1 % | <0.002 | 6.6 | 1 | Compact signal conditioner for PISeca™ single plate sensors, one channel |
| E-509.E03 | <0.1 % | <0.002 | 10 | 3 | Signal conditioner module for PISeca™ single-electrode sensors, optional upgrade with display or PC interface/display module |
| E-509.E3 | <0.1 % | <0.002 | 10 | 3 | Servo controller module for PISeca™ single-electrode sensors, optional upgrade with display or PC interface/display module |
| E-509.CxA | <0.05 % | 0.0005 | 3 | 1 to 3 | Servo controller module for piezo nano-positioning systems featuring two-plate sensors, upgradeable with piezo amplifier module, display or PC interface/display module |

*Custom dimensions, sensors, designs for volume buyers



E-509.E03 3-channel signal conditioner module in an E-501 9.5" chassis (left) with an E-515 display module, PISeca™ sensor probes D-510.050, D-510.020 and D-510.100 in front (from left)



Capacitive 2-plate sensors with control electronics. Standard sensor models D-015, D-050 and D-100 (front, left to right) and a selection of custom sensors, E-509.C3A 3-channel sensor / servo controller module in an E-501 chassis in the background



Custom, 7-channel, capacitive position sensor electronics

D-510

PISeCa™ Single-Electrode Capacitive Sensors for Sub-Nanometer Precision Measurements



PISeCa™ high-precision capacitive sensor probes with E-852 signal conditioner electronics. Sensor heads (from left): D-510.100 with 100 µm, D-510.050 with 50 µm, D-510.020 with 20 µm nominal measurement range

- Non-Contact Measurement for Distance / Motion / Vibration
- Absolute Position Sensing
- Sub-Nanometer Resolution
- Measurement Ranges to 500 µm
- Easy Integration
- High Bandwidth

Application Examples

- Semiconductor technology / test & measurement
- Data storage
- Automotive industry
- Metrology
- Precision machining

Ordering Information

D-510.020
PISeCa™ Single-Electrode Capacitive Sensor Probe, 8 mm diameter, 20 µm nominal range

D-510.050
PISeCa™ Single-Electrode Capacitive Sensor Probe, 12 mm diameter, 50 µm nominal range

D-510.100
PISeCa™ Single-Electrode Capacitive Sensor Probe, 20 mm diameter, 100 µm nominal range

Ask about custom designs!

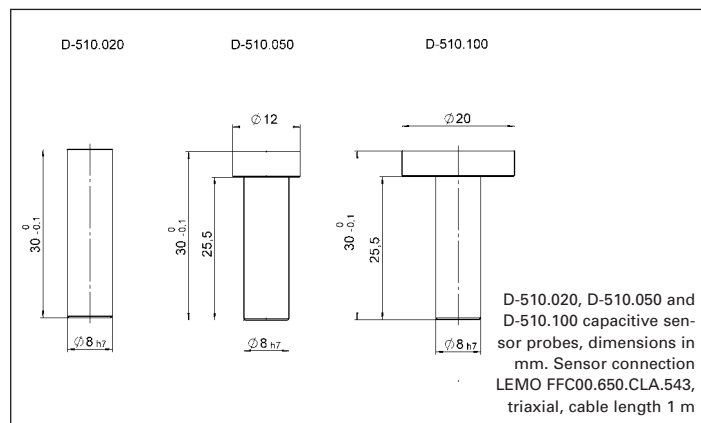

Technical Data

| | D-510.020 | D-510.050 | D-510.100 | Unit |
|--|------------------------------|------------------------------|------------------------------|------------------------|
| Sensor type | Single-electrode, capacitive | Single-electrode, capacitive | Single-electrode, capacitive | |
| Measurement accuracy | | | | |
| Nominal measurement range* | 20 | 50 | 100 | µm |
| Min. gap | 10 | 25 | 50 | µm |
| Max. gap | 150 | 375 | 750 | µm |
| Static resolution** | <0.001 | <0.001 | <0.001 | % of measurement range |
| Dynamic resolution** | <0.002 | <0.002 | <0.002 | % of measurement range |
| Linearity*** | <0.2 | <0.1 | <0.1 | % |
| Mechanical properties | | | | |
| Sensor active diameter | 3.8 | 6 | 8.4 | mm |
| Sensor active area | 11.2 | 27.9 | 56.1 | mm ² |
| Sensor diameter | 8 | 12 | 20 | mm |
| Sensor area | 50.3 | 113.1 | 314.0 | mm ² |
| Mounting shaft diameter | 8 | 8 | 8 | mm |
| Miscellaneous | | | | |
| Operating temperature range | -20 to +100 | -20 to +100 | -20 to +100 | °C |
| Material | Stainless steel | Stainless steel | Stainless steel | |
| Mass | 8 | 10 | 16 | g |
| Recommended signal conditioner electronics | E-852.10 | E-852.10 | E-852.10 | |

* Extended measurement ranges available for calibration with E-852 signal conditioner electronics

** Static resolution: bandwidth 10 Hz, dynamic: bandwidth 6.6 kHz, with E-852.10 signal conditioner electronics

*** Linearity over nominal measurement range

E-852

PISeca™ Signal Conditioner Electronics for Single-Electrode Capacitive Sensors



E-852 signal conditioner electronics with D-510.100 PISeca™ capacitive sensor probe

- Cost-Effective System Solution for PISeca™ Capacitive Position Sensor Probes
- Special Linearization System (ILS) for Maximum Linearity
- Bandwidth Adjustable from 10 Hz to 6.6 kHz
- Multiple Measurement Ranges per Probe
- LED-Bar Measuring-Range Display for Easy Setup & Sensor Installation
- External Synchronization for Multi-Channel Applications

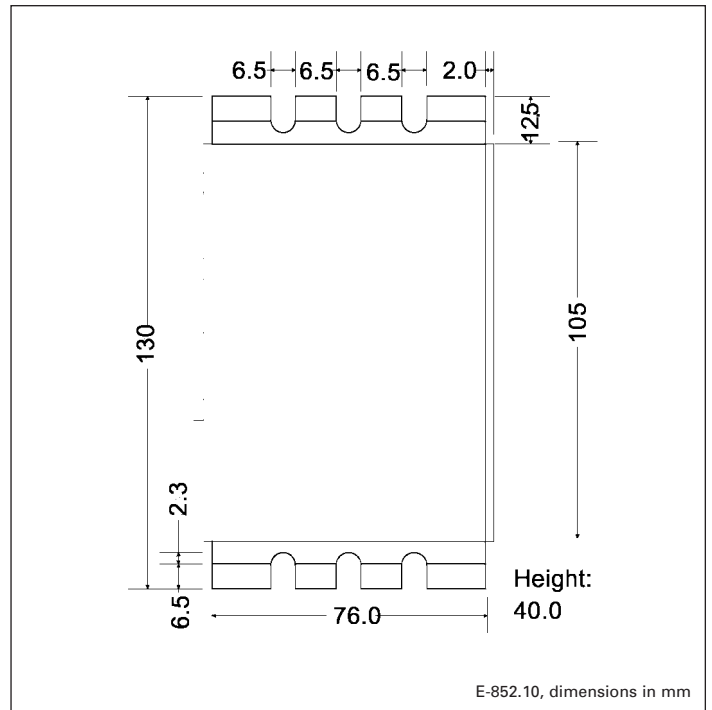

E-852.10, dimensions in mm

Technical Data

| | E-852 |
|--------------------------------------|---|
| Function | Signal conditioner for PISeca™ capacitive sensor probes |
| Channels | 1 |
| Sensor | |
| Sensor type | Single-electrode, capacitive |
| Sensor bandwidth | 6.6 / 3 / 0.3 kHz 1.1 / 0.1 / 0.01 kHz (option) |
| Measurement range extension factors* | 1 & 2.5 (calibrated); 2 & 5 (option) |
| Ext. synchronization | Auto master-slave |
| Temperature stability | 1.56 mV / °C |
| Electrical properties | |
| Output voltage | -10 to +10 V / -5 to +5 V / 0 to +10 V |
| Output signal | 1 kΩ / 1 nF |
| Supply voltage | ±15 V (125 mA), +5 V (20 mA) supplied by (E-852.PS) / ±15 V |
| Static resolution** | <0.001 % of measurement range (RMS) |
| Dynamic resolution** | <0.002 % of measurement range (RMS) |
| Noise factor*** | 0,14 ppm / √Hz |
| Linearity @ nominal range | <0.1% (<0.2 & for D-510.020) |
| Interface and operation | |
| Sensor connection | LEMO ECP.00.650.NLL.543 socket, triaxial |
| Analog output | BNC |
| Display | LED bar (gap indicator) |
| Linearization | ILS |
| Miscellaneous | |
| Operating temperature range | +5 to +40 °C |
| Weight | 0.355 kg, E-852.PS: 1.2 kg |
| Dimensions | 80 x 130 x 40 mm, E-852.PS: 100 x 170 x 62 mm |
| Target Ground Connector | Banana jack |

Application Examples

- Semiconductor technology / test & measurement
- Data storage
- Automotive industry
- Metrology
- Precision machining

Ordering Information

E-852.10
PISeca™ Signal Conditioner Electronics for Single Electrode Capacitive Sensors, 1 Channel (with E-852.PS Power Supply)

Ask about custom designs!

* Extension factors to multiply by the nominal measurement range
 ** Static: bandwidth 10 Hz, dynamic: bandwidth 6.6 kHz, cable length 1 m
 *** Change of active surface size in ppm (parts per million), refers to measurement range

D-015 · D-050 · D-100

Capacitive Two-Plate Position Sensors with Sub-Nanometer Resolution

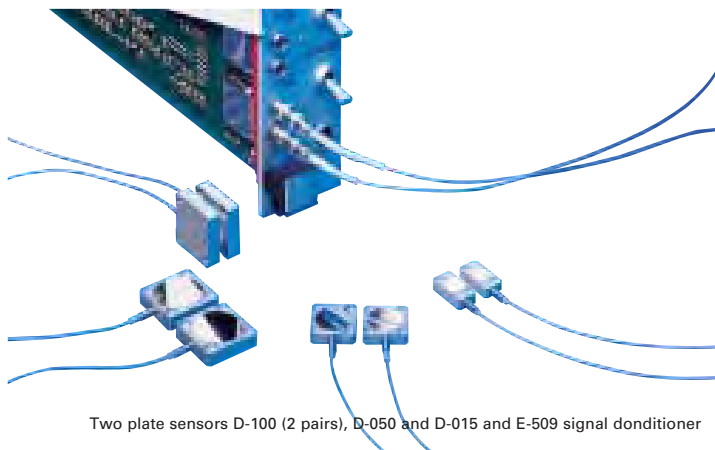

Two plate sensors D-100 (2 pairs), D-050 and D-015 and E-509 signal conditioner

- For Applications Requiring Highest Precision
- Measurement Range to 1000 microns
- Resolution to 0.01 nm
- Linearization to 0.01 % (with E-509.CxA)
- Bandwidth up to 10 kHz
- Servo Controller E-509.CxA, Compatible with E-500 Controller System
- Custom Design

Application Examples

- Semiconductor technology
- Metrology
- Precision machining

E-509.C1A · 2A · 3A

Sensor/Servo Control Modules for Piezo Positioning Systems w/ Capacitive Sensors

- Position Servo-Control Module for Piezos Positioning Systems with 2-Plate Capacitive Sensors
- 1-, 2- and 3-Channel Versions for Ultra-High Precision Closed-Loop Nanopositioning Applications
- Integrated Linearization System (ILS) for Improved Linearity
- Eliminates Drift and Hysteresis
- Virtually Increases Piezo Stiffness

* Change of active surface size in ppm (parts per million), refers to measurement range

Ordering Information

| | |
|--|---|
| D-015.00 Capacitive 2-Plate Position Sensor, 15 µm, Aluminum | E-509.C3A Piezo Sensor / Servo-Controller Module, Capacitive Sensors, 3 Channels |
| D-050.00 Capacitive 2-Plate Position Sensor, 50 µm, Aluminum | Accessories: |
| D-100.00 Capacitive 2-Plate Position Sensor, 100 µm, Aluminum | E-500.00 19"-Chassis for Modular Sensor / Piezo Servo-Controllers, 1 to 3 Channels |
| Ask about custom designs! | E-501.00 9.5" Chassis for Modular Sensor / Piezo Servo-Controllers, 1 to 3 Channels |
| E-509.C1A Piezo Sensor / Servo-Controller Module, Capacitive Sensor, 1 Channel | E-515.03 Display Module for Displacement/Piezo Voltage, 3 Channels |
| E-509.C2A Piezo Sensor / Servo-Controller Module, Capacitive Sensors, 2 Channels | E-516.i3 Interface- / Display Module, 20 Bit D/A, IEEE 488 / RS-232, 3 Channels |

Technical Data

| | D-015.00 | D-050.00 | D-100.00 | Units |
|--------------------------------|------------|------------|------------|------------------------|
| Sensor | | | | |
| Sensor type | Capacitive | Capacitive | Capacitive | |
| Nominal measurement range | 15 | 50 | 100 | µm |
| Extended measurement range | 45 | 150 | 300 | µm |
| Resolution* | 0.0005 | 0.0005 | 0.0005 | % of measurement range |
| Linearity | 0.003 | 0.003 | 0.003 | % |
| Sensor active area | 16.60 | 67.70 | 113.10 | mm ² |
| Thermal drift** | 50 | 50 | 50 | ppm/K |
| Miscellaneous | | | | |
| Operating temperature range | -20 to 80 | -20 to 80 | -20 to 80 | °C |
| Material*** | Aluminum | Aluminum | Aluminum | |
| Recommended sensor electronics | E-509.CxA | E-509.CxA | E-509.CxA | |

* 3 kHz, with E-509.C3A servo controller

** Change of active surface size in ppm (parts per million), refers to measurement range

*** Ask for custom materials

Technical Data

| | E-509.C1A / E-509.C2A / E-509.C3A |
|---------------------------------|--|
| Function | Sensor & Position Servo-Control Modules for Piezo-Driven Nanopositioning Systems |
| Sensor | |
| Servo characteristics | Analog proportional-integral (P-I) algorithm with notch filter |
| Sensor type | Two-plate capacitive sensor |
| Sensor channels | 1 / 2 / 3 |
| Sensor bandwidth | 0.3 bis 3 kHz (jumper selectable); up to 10 kHz on request |
| Measurements ranges | nominal / x3 |
| Temperature drift* | -30 ppm / °K |
| Noise factor* | 0.115 ppm / √Hz |
| Linearity error | <0.05 % |
| Interfaces and operation | |
| Sensor connection | LEMO EPL.00.250.NTD |
| Analog output | ±5 V (0 V–10 V) |
| Sensor monitor socket | LEMO 6-pin FGG.0B.306.CLAD56 |
| Supported functionality | ILS |
| Display | Overflow LED (one per channel) |
| Linearization | ILS |
| Miscellaneous | |
| Operating temperature range | +5 °C to +50 °C |
| Dimensions | 7T/3H |
| Mass | 0.2 / 0.25 / 0.35 kg |
| Operating voltage | ±15 V requires E-530 / E-531 power supply (E-500 / E-501 system) |

Tutorial

Resolution / Bandwidth

Resolution in nanopositioning relates to the smallest change in displacement that can still be detected by the measuring devices.

For capacitive sensors, resolution is in principle unlimited, and is in practice limited by electronic noise. PI signal conditioner electronics are optimized for high linearity, bandwidth and minimum noise, enabling sensor resolution down to the picometer range.

Electronic noise and sensor signal bandwidth are interdependent. Limiting the bandwidth reduces noise and thereby improves resolution. The working distance also influ-

ences the resolution: the smaller the working distance of the system, the lower the absolute value of the electronic noise.

Figure 1 shows measurements of nanometer-range actuator cycles taken with a D-015, 15 μm capacitive position sensor and a laser interferometer. The graphs clearly show the superior performance of the capacitive position sensing technique.

Figure 2 illustrates the influence of bandwidth upon resolution: the PISeca™ single-electrode sensors show excellent resolution down to the sub-nanometer range, even at high bandwidths.

Linearity and Stability of PI sensors

The linearity of a measurement denotes the degree of constancy in the proportional relation between change in probe-target distance and the output signal. Usually linearity is given as linearity error in percent of the full measurement range. A linearity error of 0.1% with range of 100 μm gives a maximum error of 0.1 μm . Linearity error has no influence whatsoever upon resolution and repeatability of a measurement.

Linearity is influenced to a high degree by homogeneity of the electric field and thus by any non-parallelism of the probe and target in the application. PI capacitive position sensor electronics incorporate a propri-

etary design providing superior linearity, low sensitivity to cable capacitance, low background noise and low drift. The Integrated Linearization System (ILS) compensates for non-parallelism influences.

A comparison between a conventional capacitive position sensor system and a PI ILS system is shown in Figure 3. When used with PI digital controllers (which add polynomial linearization) a positioning linearity of up to 0.003% is achievable.

Figure 4 shows the linearity of a P-752.11C piezo flexure nanopositioning stage with integrated capacitive position sensor operated in closed-loop

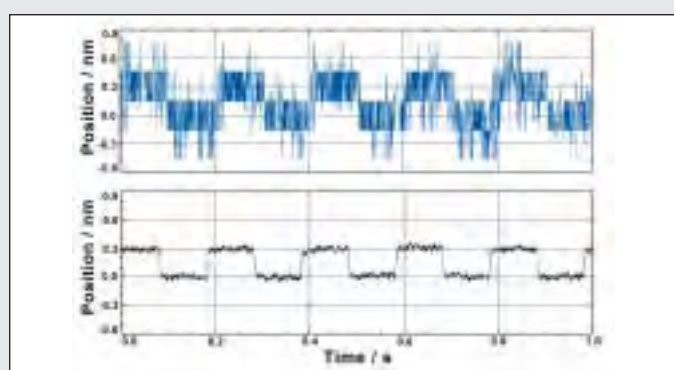

Fig. 1: Piezo nanopositioning system making 0.3 nm steps, measured with PI capacitive sensor (lower curve) and with a highly precise laser interferometer. The capacitive sensor provides significantly higher resolution than the interferometer

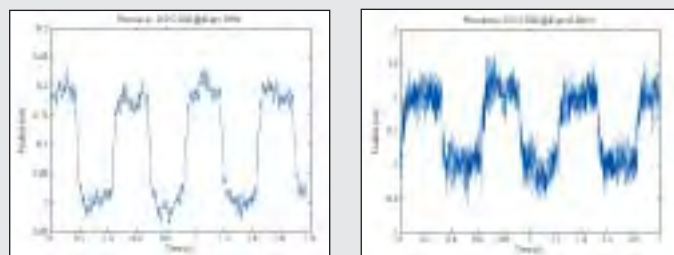

Fig. 2: Resolution significantly below 1 nm is achieved with a 20 μm PISeca™ single-electrode sensor (D-510.020) and the E-852 signal conditioner electronics. Left: 0.2 nm-steps under quasi-static conditions (bandwidth 10 Hz), right: 1 nm-steps with maximum bandwidth (6.6 kHz)

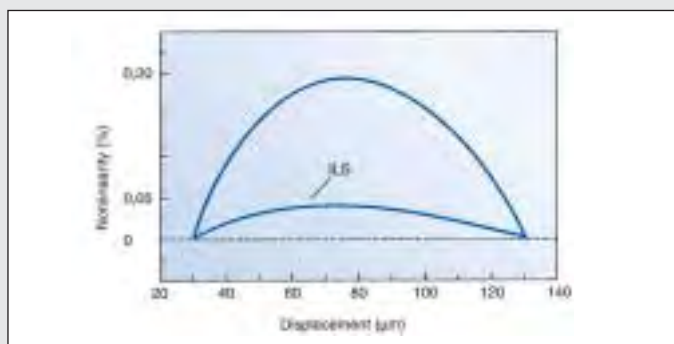

Fig. 3: Linearity of conventional capacitive position sensor system vs. PI ILS (integrated linearization system), shown before digital linearization

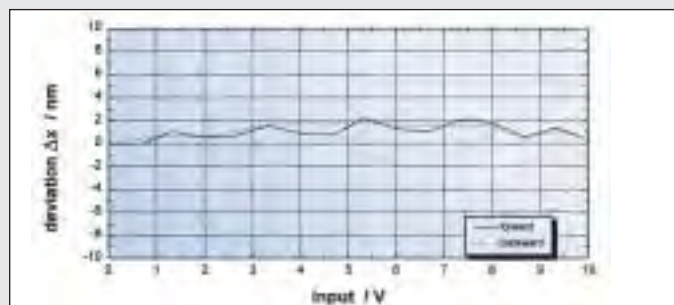

Fig. 4: Linearity of a P-752.11C, 15 μm piezo nanopositioning stage operated with E-500/E-509.C1A control electronics. The travel range is 15 μm , the gain 1.5 $\mu\text{m}/\text{V}$. Linearity is better than 0.02%; even higher linearity is achievable with PI digital controllers

mode with an analog controller. All errors contributed by the mechanics, PZT drive, sensors and electronics are included in the resulting linearity of better than 0.02%. Even higher linearity is achievable with PI digital controllers like the E-710.

Stability of the measurement is limited mainly by thermal and

electronic drift. For accuracy and repeatability reasons, it is thus necessary to maintain constant environmental conditions. The exceptional long-term stability of the PI capacitive position sensor and electronics design is shown in Figure 5.

Principle of the Measurement

Signal/Displacement Proportionality

When a voltage is applied to the two plates of an ideal capacitor, it creates a homogenous electric field. Apart from constant factors, the electrical capacitance of the set-up is determined by sensor area and plate distance. Thus, a change in displacement leads directly to a change in capacitance. This value is matched to a reference capacitance in a bridge circuit.

Design of the signal conditioner electronics is such that the output signal is proportional to the gap change. The planes of the sensor surface ("probe") and the target form the two capacitor plates. The target should not be below a certain size because

of boundary effects. This is important for applications with, say, a rotating drum as target. For metallic materials, the thickness of the target has no influence on the measurement.

Guard Ring Geometry/Design

The proportionality referred to is based on the homogeneity of the electric field. To eliminate boundary effects, the superior PI design uses a guard-ring electrode that surrounds the active sensor area and is actively kept at the same potential (see Fig. 7). This design shields the active sensor area and provides for excellent containment of the measurement zone. Thus optimum measuring linearity over the full range is achieved within the specified accuracy.

Calibration for Best Accuracy

PI's nanometrology calibration laboratories offer optimum conditions for factory calibration. As references, ultra-high-accuracy incremental sensors like laser interferometers are used.

PISeca™ systems are calibrated at PI with a NEXLINE® positioning system having a

closed-loop resolution better than 0.01 nm in a test stand with friction-free flexure guidance and an incremental reference sensor featuring a resolution better than 0.1 nm (Fig. 8 and 9).

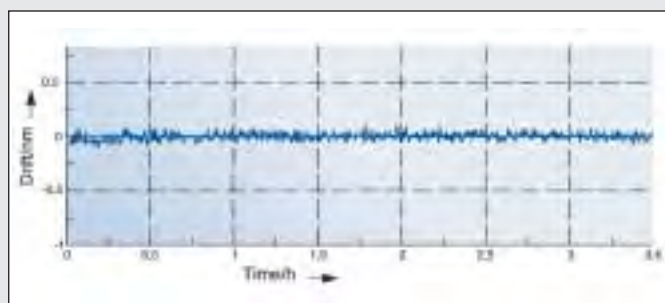

Fig. 5: Measurement stability of an E-509.C1A capacitive position sensor control module with 10 pF reference capacitor over 3.5 hours (after controller warm-up)

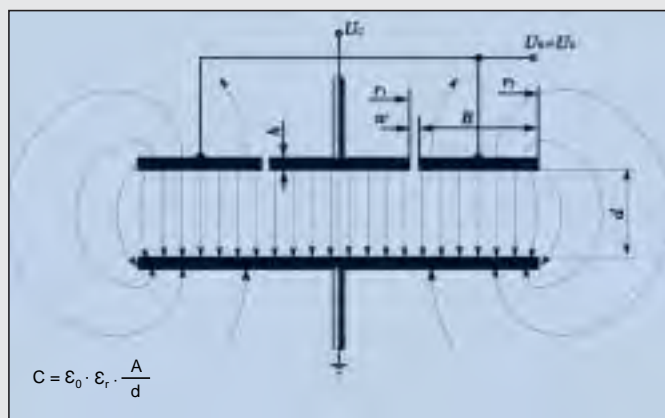

Fig. 6: Capacitive sensor working principle. The capacitance C is proportional to the active sensor area A, ϵ_0 is constant, ϵ_r is the dielectric constant of the material between the plates, generally air



Fig. 7: Capacitive sensors with guard ring design provide superior linearity

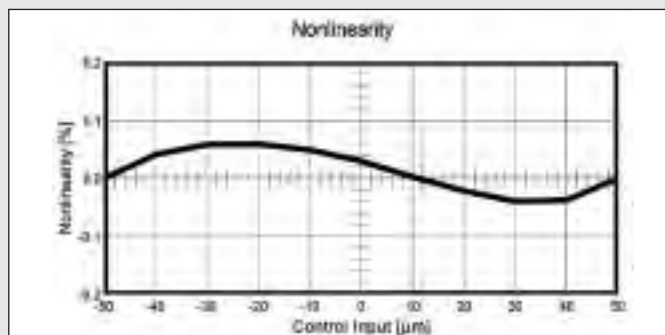

Fig. 8: Output linearity error of a PISeca™ single-electrode system is typically less than 0.1% over the full measurement range

Direct Metrology, Parallel Metrology

Direct Metrology / Parallel Metrology with Two-Plate Capacitive Sensors

Capacitive sensors are the ideal choice for nanometrology applications in positioning, scanning and metrology requiring the highest possible accuracy. Two-plate capacitive sensors achieve the highest linearity and long-term stability. The measurement probe can be attached directly to the moved surface (direct metrology) and provide absolute, non-contact displacement values against a reference

surface, with no influence whatsoever on the motion performed. These sensors are particularly well-suited for parallel-kinematics nanopositioning systems. There, in a multi-axis system, motion in all degrees of freedom is measured against a common reference, and the runout of the various actuators can be compensated out in real time (active trajectory control). In this way, motion accuracies in the subnanometer and submicroradian ranges can be achieved.

Special Design Eliminates Cable Influences

When measuring distance by detection of capacitance changes, fluctuations in the cable capacitance can have an adverse effect on accuracy. This is why most capacitive measurement systems only provide satisfactory results with short, well-defined cable lengths.

PI systems use a special design which eliminates cable influ-

ences, permitting use of cable lengths of up to 3 m without difficulty. For optimum results, we recommend calibration of the sensor-actuator system in the PI metrology lab.

Longer distances between sensor and electronics can be spanned with special, loss-free, digital transmission protocols.

Electrode Geometry, Sensor Surface Flatness and Finish

During sensor production, great care is taken to maintain critical mechanical tolerances. Measuring surfaces are diamond machined using sophisticated

process control techniques. The result is the smooth, ultra-flat, mirrored surfaces required to obtain the highest resolution commercially available.

Parallelism of Measuring Surfaces

For optimum results, target and probe plates must remain parallel to each other during measurement. For small measurement distances and small active areas, any divergence has a strong influence on the measurement results. Tilt adversely

affects linearity and gain, although not resolution or repeatability (see fig. 12). Positioning systems with multi-link flexure guidance reduce tip and tilt to negligible levels (see Fig. 13) and achieve outstanding accuracy.

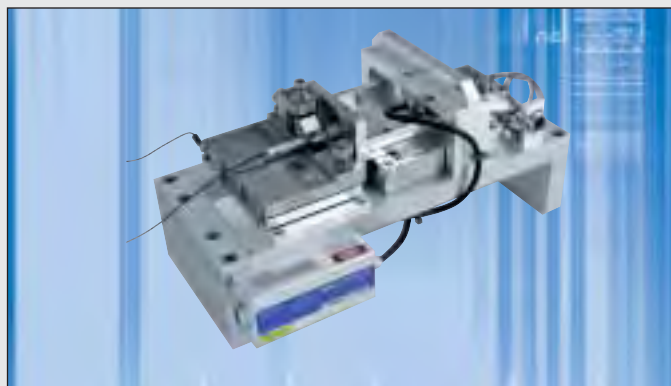

Fig. 9: Ultra-high-precision NEXLINE® positioning system with incremental sensor in a calibration and test stand for PISeca™ sensors. The resolution is significantly better than that of a laser interferometer



Fig. 10: Capacitive position sensors in an ultra-high-accuracy, six-axis nanopositioning system designed by PI for the German National Metrology Institute (PTB). Application: scanning microscopy

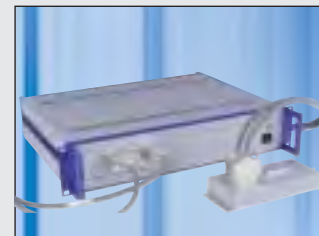

Fig. 11: Digital sensor-signal transmission (DST) allows a distance up to 15 m between positioning unit and controller, here an E-710 multi-axis digital piezo controller

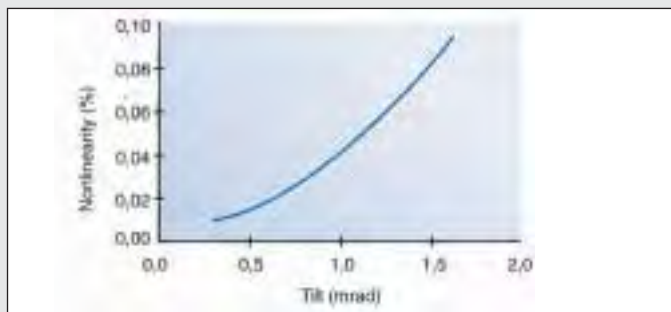

Fig. 12: Nonlinearity vs. tilt. Resolution and repeatability are not affected by tilt

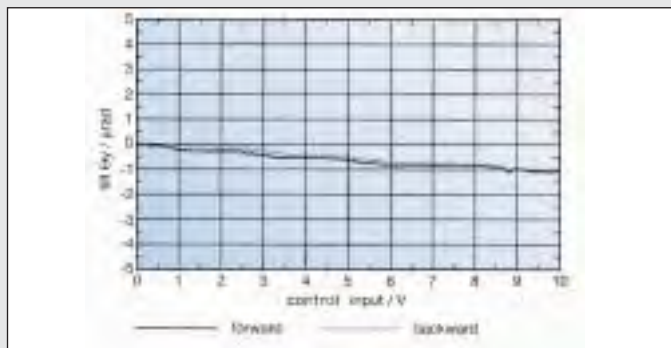

Fig. 13: Flexure-guided nanopositioning systems like the P-752 offer submicroradian guiding accuracy and are optimally suited for capacitive sensors

Glossary

Measurement Range

The measurement range depends on the size of the active sensor area as well as on the electronics used.

Due to PI's proprietary signal conditioner electronics design, the mid-range distance is always identical to the selected measurement range. The probe-to-target gap may vary from

50% to 150% of the measurement range (see Fig. 14).

The sensor capacitance is the same as that of the reference capacitance in the electronics. Different reference capacitances can be used to extend the nominal (standard) measurement range (see Fig. 15).

Target

Two-electrode capacitive sensors consist of two electrodes, named probe and target.

Single-electrode sensors measure against a surface that is called the target. The target surface is, in principle, a conductive material electrically connected to ground. Measurement against semi-conductors is possible as well.

While two-plate capacitive sensors consist of two well-defined

high-quality planes, with single-plate sensors, target surface characteristics can influence the results. A curved or rough surface will deteriorate the resolution because the results refer to an average gap (see Fig. 16 and 17). Surface shape also influences the homogeneity of the electric field and thereby the measurement linearity. For factory calibration, a target plane that is considerably larger than the sensor area is used.

Environment

Precision measurement with nanometer accuracy requires minimizing environmental influences. Constancy of temperature and humidity during the measurement are as essential as cleanliness.

Electronics from PI are basically very temperature stable. Temperature drift is under 0.2% of full measurement range with a change of temperature of 10 C°. Temperature changes also cause all material in the system to expand or contract, thus

changing the actual measured gap.

The influence of a change in relative humidity of 30 percentage points is less than 0.5% of the measurement range. Condensation must always be avoided. Dusty or damaged sensor surfaces will also worsen the measurement quality.

Environmental conditions at the time of calibration are noted on the calibration sheet PI provides with each individual system.

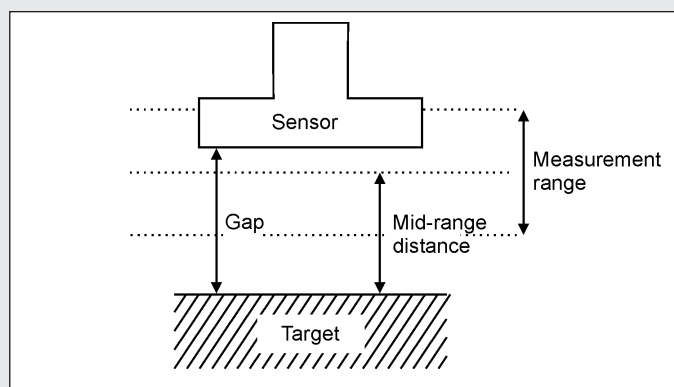

Fig. 14: Definitions: measurement range and mid-range distance have identical values

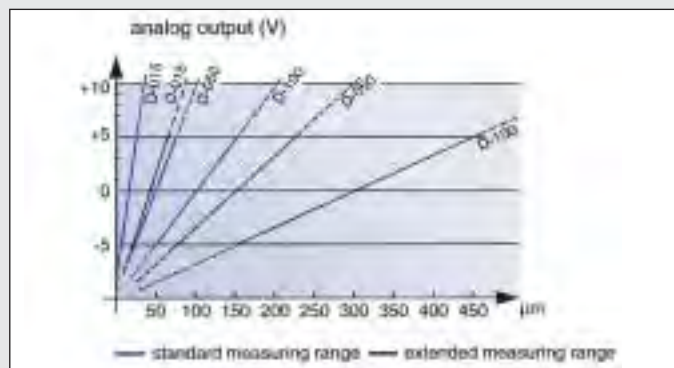

Fig. 15: Measuring ranges of different PI capacitive position sensors (standard ranges in blue, extended ranges in black)

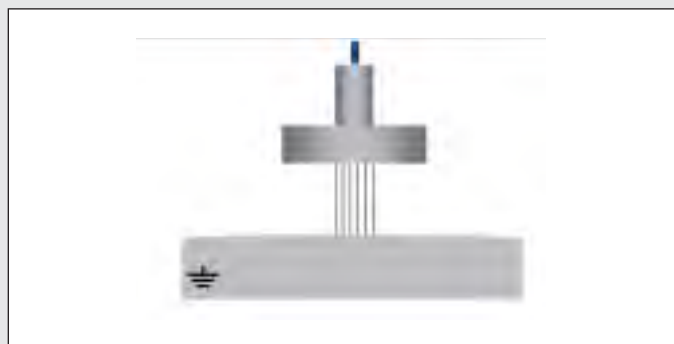

Fig. 16: Roughness of the target surface downgrades resolution and linearity



Fig. 17: Curved surfaces lead to an averaged distance measurement

Request the hardbound PI Catalog



Call or go to: <http://www.pi.ws>

Program Overview

- Piezoelectric Actuators
- Piezo Nanopositioning Systems and Scanners
- Active Optics / Tip-Tilt Platforms
- Capacitive Sensors
- Piezo Electronics: Amplifiers and Controllers
- Hexapods
- Micropositioners
- Positioning Systems for Fiber Optics, Photonics and Telecommunications
- Motor Controllers
- PLine® High-Speed Ceramic Linear Motors

Headquarters

GERMANY

Physik Instrumente (PI) GmbH & Co. KG
 Auf der Römerstr. 1
 D-76228 Karlsruhe/Palmbach
 Tel: +49 (721) 4846-0
 Fax: +49 (721) 4846-100
 info@pi.ws · www.pi.ws

PI Ceramic GmbH
 Lindenstr.
 D-07589 Lederhose
 Tel: +49 (36604) 882-0
 Fax: +49 (36604) 882-25
 info@piceramic.de
 www.piceramic.de

Subsidiaries

USA (East) & CANADA

PI (Physik Instrumente) L.P.
 16 Albert St.
 Auburn, MA 01501
 Tel: +1 (508) 832 3456
 Fax: +1 (508) 832 0506
 info@pi-usa.us
 www.pi-usa.us

USA (West) & MEXICO

PI (Physik Instrumente) L.P.
 5420 Trabuco Rd., Suite 100
 Irvine, CA 92620
 Tel: +1 (949) 679 9191
 Fax: +1 (949) 679 9292
 info@pi-usa.us
 www.pi-usa.us

JAPAN

PI Japan Co., Ltd.
 Akebono-cho 2-38-5
 Tachikawa-shi
 J-Tokyo 190
 Tel: +81 (42) 526 7300
 Fax: +81 (42) 526 7301
 info@pi-japan.jp
 www.pi-japan.jp

PI Japan Co., Ltd.
 Hanahara Dai-ni Building, #703
 4-11-27 Nishinakajima,
 Yodogawa-ku, Osaka-shi
 J-Osaka 532
 Tel: +81 (6) 6304 5605
 Fax: +81 (6) 6304 5606
 info@pi-japan.jp
 www.pi-japan.jp

CHINA

Physik Instrumente (PI Shanghai) Co., Ltd.
 Building No. 7-301
 Longdong Avenue 3000
 201203 Shanghai, China
 Tel: +86 (21) 687 900 08
 Fax: +86 (21) 687 900 98
 info@pi-china.cn
 www.pi-china.cn

GREAT BRITAIN

Lambda Photometrics Ltd.
 Lambda House
 Batford Mill
 GB-Harpenden, Hertfordshire
 AL5 5BZ
 Tel: +44 (1582) 764 334
 Fax: +44 (1582) 712 084
 pi@lambdaphoto.co.uk
 www.lambdaphoto.co.uk

FRANCE

Polytec PI/RMP S.A.
 32 rue Delizy
 F-93694 Pantin Cedex
 Tel: +33 (1) 481 039 30
 Fax: +33 (1) 481 008 03
 pi.pic@polytec-pi.fr
 www.polytec-pi.fr

ITALY

Physik Instrumente (PI) S.r.l.
 Via G. Marconi, 28
 I-20091 Bresso (MI)
 Tel: +39 (02) 665 011 01
 Fax: +39 (02) 665 014 56
 info@pionline.it
 www.pionline.it