

P-725 PIFOC Long-Travel Objective Scanner



P-725.xDD PIFOC High-Dynamics Piezo Scanner



Contents

About this Document.....	3
Symbols and Typographic Conventions	3
Figures.....	3
Safety.....	3
Intended Use	3
Safety Precautions.....	4
Product Description	5
Model Overview	5
Product View.....	6
Product Labeling.....	7
Scope of Delivery.....	7
Accessories	8
Suitable Electronics	9
Installation.....	9
Connecting the P-725 to the Protective Earth Conductor	9
Affixing the P-725 to the Microscope.....	10
Installing the Objective.....	12
Startup and Operation.....	13
General Notes on Startup and Operation.....	13
Starting Up and Operating the P-725	14
Discharging the P-725.....	14
Maintenance.....	15
Cleaning the P-725	15
Customer Service	15
Technical Data	16
P-725 PIFOC Long-Travel Objective Scanner.....	16
P-725.xDD Fast PIFOC High-Dynamics Piezo Scanner.....	18
Dimensions	19
P-725.xCD, P-725.xCL, P-725.x0L	19
P-725.xCA	20
P-725.xDD	21
Pin Assignments	22
P-725.xCL, P-725.x0L.....	22
P-725.SDD	23
P-725.xCD, P-725.xCA, P-725.CDD	24
Maximum Ratings.....	24
Ambient Conditions and Classifications	25
Old Equipment Disposal	25

About this Document

Symbols and Typographic Conventions

The following symbols and typographic conventions are used in this user manual:

CAUTION



Dangerous situation

If not avoided, the dangerous situation will result in minor injury.

- Actions to take to avoid the situation.

NOTICE



Dangerous situation

If not avoided, the dangerous situation will result in damage to the equipment.

- Actions to take to avoid the situation.

INFORMATION

Information for easier handling, tricks, tips, etc.

Figures

For better understandability, the colors, proportions, and degree of detail in illustrations can deviate from the actual circumstances. Photographic illustrations may also differ and must not be seen as guaranteed properties.

Safety

Intended Use

The P-725 is a laboratory device as defined by DIN EN 61010-1. It is intended to be used in interior spaces and in an environment which is free of dirt, oil and lubricants.

Based on its design and realization, the P-725 is intended for positioning and shifting microscope objectives in one axis.

The P-725 Z drive can be mounted horizontally or vertically. The specifications refer to a vertically mounted Z drive.

The intended use of the P-725 is only possible in a completely assembled and connected state. The P-725 must be operated with a suitable controller that is available from PI. The controller is not included in the scope of delivery of the P-725.

Safety Precautions

CAUTION



Dangerous voltage and residual charge on piezo actuators!

The P-725 is driven by piezo actuators. Temperature changes and compressive stresses can induce charges in piezo actuators. After being disconnected from the electronics, piezo actuators can also stay charged for several hours. Touching or short-circuiting the contacts in the connector of the P-725 can lead to minor injuries. In addition, the piezo actuators can be destroyed by an abrupt contraction.

- Do **not** open the P-725.
- Discharge the piezo actuators before installation:
Connect the piezo actuator to the switched-off PI controller.
- Do **not** pull out the connector from the electronics during operation.



For P-725 with sub-D connector:

Touching the contacts in the connector can lead to an electric shock (max. 120 V DC) and minor injuries.

- Do **not** touch the contacts in the connector.
- Secure the connector of the piezo actuator with screws against being pulled out of the controller.

CAUTION



Risk of electric shock if the protective earth conductor is not connected!

If a protective earth conductor is not or not properly connected, dangerous touch voltages can occur and there is a risk of electric shock. In the case of malfunction or failure of the system, touching the P-725 can result in minor injuries.

- Connect the P-725 to a protective earth conductor before startup.
- Do **not** remove the protective earth conductor during operation.
- Use electrically conductive materials (e.g., screws and flat washers) for mounting the protective earth conductor.
- Make sure that the contact resistance is $<0.1 \Omega$ at 25 A at all connection points relevant for mounting the protective earth conductor.
- If the protective earth conductor has to be temporarily removed (e.g., for modifications), reconnect the P-725 to the protective earth conductor before starting it up again.

NOTICE



Unsuitable cables!

Unsuitable cables can damage the electronics.

- Only use cables from PI for connecting the P-725 to the electronics.

INFORMATION

Extended cables can affect the performance of the P-725.

- Do **not** use cable extensions. If you need longer cables, contact our customer service department (p. 15).

Product Description

Model Overview

The models of the P-725 differ in terms of:

- Travel range
- Sensor
- Connector
- Thread adapter

Product number	Description
P-725.1CA	PIFOC piezo nanofocusing Z drive for long scanning ranges, 100 µm, capacitive sensors, sub-D connector, for large aperture QuickLock thread adapters
P-725.1CD	PIFOC piezo nanofocusing Z drive for long scanning ranges, 100 µm, capacitive sensors, sub-D connector, for QuickLock thread adapters
P-725.1CL	PIFOC piezo nanofocusing Z drive for long scanning ranges, 100 µm, capacitive sensors, LEMO connectors, for QuickLock thread adapters
P-725.10L	PIFOC piezo nanofocusing Z drive for long scanning ranges, 150 µm, open-loop, LEMO connectors, for QuickLock thread adapters
P-725.2CA	PIFOC piezo nanofocusing Z drive for long scanning ranges, 250 µm, capacitive sensors, sub-D connector, for large aperture QuickLock thread adapters
P-725.2CD	PIFOC piezo nanofocusing Z drive for long scanning ranges, 250 µm, capacitive sensors, sub-D connector, for QuickLock thread adapters
P-725.2CL	PIFOC piezo nanofocusing Z drive for long scanning ranges, 250 µm, capacitive sensors, LEMO connectors, for QuickLock thread adapters
P-725.20L	PIFOC piezo nanofocusing Z drive for long scanning ranges, 330 µm, open-loop, LEMO connectors, for QuickLock thread adapters
P-725.4CA	PIFOC piezo nanofocusing Z drive for long scanning ranges, 400 µm, capacitive sensors, sub-D connector, for large aperture QuickLock thread adapters

Product number	Description
P-725.4CD	PIFOC piezo nanofocusing Z drive for long scanning ranges, 400 μm , capacitive sensors, sub-D connector, for QuickLock thread adapters
P-725.4CL	PIFOC piezo nanofocusing Z drive for long scanning ranges, 400 μm , capacitive sensors, LEMO connectors, for QuickLock thread adapters
P-725.40L	PIFOC piezo nanofocusing Z drive for long scanning ranges, 460 μm , open-loop, LEMO connectors, for QuickLock thread adapters
P-725.CDD	Fast PIFOC piezo nanofocusing Z drive, 18 μm , capacitive sensor, sub-D connector, for QuickLock thread adapters
P-725.SDD	Fast PIFOC piezo nanofocusing Z drive, 18 μm , SGS sensor, LEMO connectors, for QuickLock thread adapters

Product View

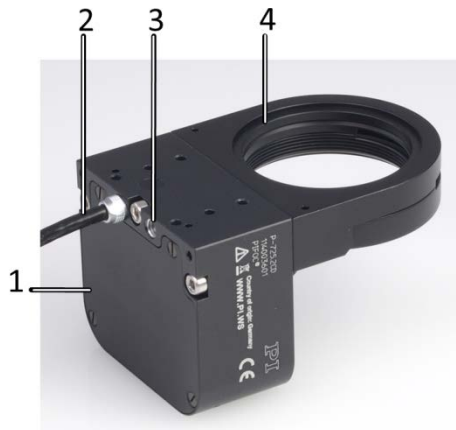







Figure 1: Components of the Z drive, example of a P-725.2CD, here without symbol for protective earth connection

- 1 Base body
- 2 Cable exit
- 3 Protective earth connection
- 4 Threaded aperture

Product Labeling

Labeling	Description
P-725.2CD	Product number (example), the digits after the period refer to the model
117003601	Serial number (example), individual for each P-725 Meaning of the places (counting from left): 1 = internal information 2 and 3 = manufacturing year 4 to 9 = consecutive numbers
PIFOC	Brand name
Country of origin: Germany	Country of origin
	Warning sign "Observe manual!"
	Old equipment disposal (p. 25)
WWW.PI.WS	Manufacturer's address (website)
	CE conformity mark
	Manufacturer's logo
	Symbol for the protective earth conductor (p. 9), marks the protective earth connection of the P-725

Scope of Delivery

Product number	Description
P-725	PIFOC piezo nanofocusing Z drive according to order (p. 5)
000036450	M4 screw set for protective earth, consisting of: <ul style="list-style-type: none"> ▪ 1 M4x8 flat-head screw with cross recess, ISO 7045 ▪ 2 safety washers ▪ 2 flat washers
PZ240EK	Short instructions for piezo positioning systems
P721T0002	Technical note for QuickLock thread option

Accessories

Extension tubes

Product number	Description
P-721.90Q	Extension tube, 12.5 mm, thread W0.8 x 1/36"
P-721.91Q	Extension tube, 12.5 mm, thread M25 x 1/36"
P-721.92Q	Extension tube, 12.5 mm, thread M26 x 1/36"
P-721.93Q	Extension tube, 12.5 mm, thread M27 x 1/36"
P-721.94Q	Extension tube, 12.5 mm, thread M28 x 1/36"
P-721.95Q	Extension tube, 12.5 mm, thread M32 x 1/36"
P-721.96Q	Extension tube, 12.5 mm, thread M26 x 1/36"
P-721.98Q	Extension tube, 12.5 mm, thread M19 x 1/36"

QuickLock thread adapters

Product number	Description
Only for P-725.xxD / .xxL	
P-721.02Q	QuickLock thread adapter, M26 x 0.75 mm, Ø 21 mm
P-721.03Q	QuickLock thread adapter, M27 x 0.75 mm, Ø 21 mm
P-721.04Q	QuickLock thread adapter, M28 x 0.75 mm, Ø 21 mm
P-721.05Q	QuickLock thread adapter, M32 x 0.75 mm, Ø 21 mm
P-721.06Q	QuickLock thread adapter, M26 x 1/36", Ø 21 mm
P-721.08Q	QuickLock thread adapter, M19 x 0.75 mm, Ø 14 mm
P-721.11Q	QuickLock thread adapter, M25 x 0.75 mm, Ø 21 mm
P-721.12Q	QuickLock thread adapter, W0.8 x 1/36", Ø 14 mm
Only for P-725.xCA	
P-721.02A	QuickLock thread adapter for large apertures, M26 x 0.75 mm, Ø 23 mm
P-721.03A	QuickLock thread adapter for large apertures, M27 x 0.75 mm, Ø 24 mm
P-721.04A	QuickLock thread adapter for large apertures, M28 x 0.75 mm, Ø 25 mm
P-721.05A	QuickLock thread adapter for large apertures, M32 x 0.75 mm, Ø 29 mm
P-721.06A	QuickLock thread adapter for large apertures, M26 x 1/36", Ø 23 mm
P-721.11A	QuickLock thread adapter for large apertures, M25 x 0.75 mm, Ø 22 mm

Adapter cables

Product number	Description
P-895.1DLC	Adapter cable Sub-D 7W2 (f) to LEMO for piezo actuator nanopositioning systems with capacitive sensors, 1 channel, 0.3 m. Fits controllers with LEMO connectors (1x voltage, 2x sensor).
P-895.1LDC	Adapter cable LEMO to sub-D 7W2 (m) for piezo actuator nanopositioning systems with capacitive sensors, 1 channel, 0.3 m. Fits motion controllers with Sub-D 7W2 (f) socket.

Suitable Electronics

Model / Mechanics	Model / Electronics
Capacitive sensor, sub-D connection: P-725.xCD P-725.xCA P-725.CDD	E-621 controller module E-625 servo controller, bench-top E-665 display servo controller, with digital interface, bench-top E-754 single-channel digital controller E-709 single-channel digital controller
Capacitive sensor, LEMO connection: P-725.xCL	E-610 servo controller / amplifier E-500 modular piezo controller system with E-505 high-performance amplifier module and E-509 controller
Strain gauge sensor, LEMO connection: P-725.SDD	E-610 servo controller / amplifier E-625 servo controller, bench-top E-665 display servo controller, with digital interface, bench-top E-709 single-channel digital controller
No sensor, LEMO connection: P-725.x0L	E-500 modular piezo controller system with E-505 high-performance amplifier module E-610.00 amplifier

Installation

Connecting the P-725 to the Protective Earth Conductor

INFORMATION

- Observe the applicable standards for mounting the protective earth conductor.

The P-725 is equipped with an M4 hole for fastening the protective earth conductor. This hole is marked with the protective earth conductor symbol  (see "Dimensions", p. 19).

Requirements

- ✓ You have read and understood the safety precautions (p. 3).
- ✓ The P-725 is **not** connected to the electronics.

Tools and accessories

- Suitable protective earth conductor: Cross-sectional area of the cable $\geq 0.75 \text{ mm}^2$
- Supplied M4 protective earth screw set (p. 7) for connecting the protective earth conductor
- Suitable screwdriver

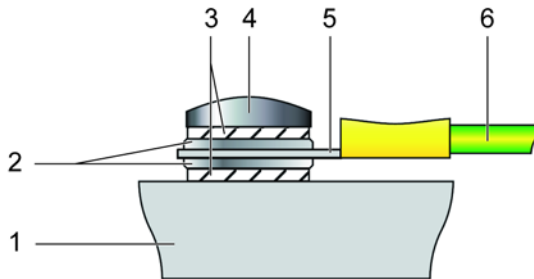

Figure 2: Mounting of the protective earth conductor (profile view)

- 1 Base body of the P-725
- 2 Flat washer
- 3 Safety washer
- 4 Screw
- 5 Cable lug
- 6 Protective earth conductor

Connecting the P-725 to the protective earth conductor

1. If necessary, fasten a suitable cable lug to the protective earth conductor.
2. Use the M4 screw (together with the washers and self-locking washers) to affix the cable lug of the protective earth conductor to the protective earth connection of the P-725 as shown in the profile view.
3. Tighten the M4 screw with a torque of 1.2 Nm to 1.5 Nm.
4. Make sure that the contact resistance at all connection points relevant for mounting the protective earth conductor is $<0.1 \Omega$ at 25 A.

Affixing the P-725 to the Microscope

The P-725 can be affixed to the microscope in one of the following ways:

- Installation using the QuickLock thread adapter (p. 10)
- Optional: Installation using the mounting holes in the base body of the P-725 (p. 11).
With this mounting option, you only need the objective insert of the QuickLock thread adapter.

Installing the P-725 Using the QuickLock Thread Adapter

Requirements

- ✓ You have read and understood the safety precautions (p. 3).

Tools and accessories

- P721T0002 technical note for PIFOC QuickLock thread option (p. 7)
- QuickLock thread adapter (p. 8) (not included)
- Suitable tools

Installing the P-725 using the QuickLock thread adapter

- Install the P-725 as described in the P721T0002 technical note for PIFOC QuickLock thread option (p. 7).

Installing the P-725 Using the Mounting Holes (Optional)

The figure serves as an example and can differ from your model.

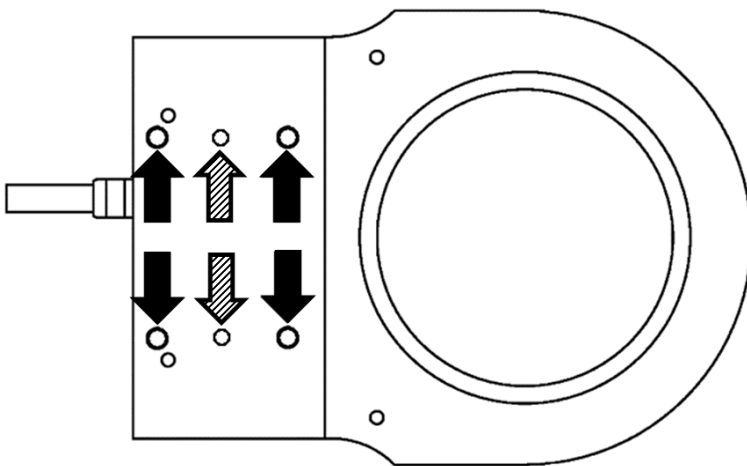

Figure 3: P-725 (example view): Mounting holes (black arrows) and locating holes (hatched arrows) in the base body of the P-725

Requirements

- ✓ You have read and understood the safety precautions (p. 3).

Tools and accessories

- P721T0002 technical note for PIFOC QuickLock thread option (p. 7)
- QuickLock thread adapter (p. 8) (not included)
Note that you only need the objective insert of the QuickLock thread adapter.
- Four M2.5 screws of suitable length (p. 19) for screwing the P-725 onto a microscope
- Optional: Two suitable locating pins (p. 19) for alignment of the P-725
- Suitable tools

Installing the P-725 using the mounting holes (optional)

1. Screw the objective insert into the P-725 as described in the P721T0002 technical note for PIFOC QuickLock thread option (p. 7).
2. Optional: Align the P-725 with the microscope using suitable locating pins and the locating holes in the base body of the P-725 (see Figure 3 above).
3. Affix the P-725 to the microscope using four suitable M2.5 screws and the mounting holes in the base body of the P-725 (see Figure 3 above).

Installing the Objective

Correct:

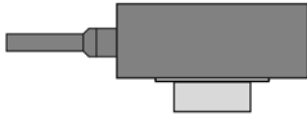

Figure 4: Center of load close to aperture

Incorrect:

Mounting the load incorrectly causes high strain on the flexure guides in the Z drive, high torques and the danger of oscillations.

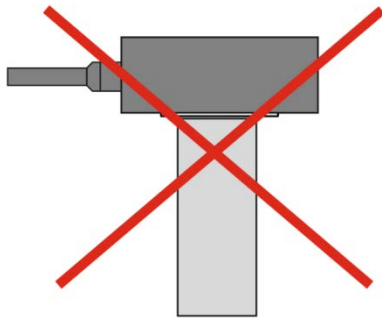

Figure 5: Center of load far below the aperture

Requirements

- ✓ You have read and understood the safety precautions (p. 3).
- ✓ You have affixed the P-725 to the microscope (p. 10).

Tools and accessories

- P721T0002 technical note for PIFOC QuickLock thread option (p. 7)
- QuickLock thread adapter (p. 8) (not included)
- Objective to be installed (not included)
- Suitable tools

Installing the objective

- Screw the objective into the P-725. See the P721T0002 technical note (p. 7) for details. Pay attention to a maximum torque of 0.6 Nm.

Startup and Operation

General Notes on Startup and Operation

NOTICE



Destruction of the piezo actuator by electric flashovers!

The use of the P-725 in environments that increase the electrical conductivity can lead to the destruction of the piezo actuator by electric flashovers. Electric flashovers can be caused by moisture, high humidity, liquids and conductive materials such as metal dust. In addition, electric flashovers can also occur in certain air pressure ranges due to the increased conductivity of the air.

- Avoid operating the P-725 in environments that can increase the electric conductivity.
- Only operate the P-725 within the permissible ambient conditions and classifications (p. 25).

NOTICE



Destruction of the piezo actuator by continuously high voltage!

The constant application of high voltage to piezo actuators can lead to leakage currents and flashovers that destroy the ceramic.

If the P-725 is not used, but the controller is to remain switched on to ensure temperature stability:

- Set the piezo voltage to 0 V on the controller.

NOTICE



Uncontrolled oscillation!

Oscillations can cause irreparable damage to the P-725. Oscillations are indicated by a humming and can result from the following causes:

- The load and/or dynamics of operation differ too much from the calibration settings.
- The P-725 is operated near its resonant frequency.
- If you notice oscillations, stop the P-725 immediately.

INFORMATION

Systems are calibrated at the factory to achieve optimum performance. Replacing the system components will cause a loss in performance when Z drives without ID chip are used, or whose ID chip does not contain any calibration data, or when Z drives with LEMO connectors or analog controllers are used.

Only P-725.xxD and P-725.xCA Z drives are equipped with an ID chip.

- Note the assignment of the Z drive axis to the controller channel, which is given by the calibration label of the piezo servo controller.
- For systems without ID chip:
If the piezo servo controller or the Z drive has to be replaced, recalibrate the axis displacement (see controller manual) or contact our customer service department (p. 15).

Starting Up and Operating the P-725**Requirements**

- ✓ You have read and understood the safety precautions (p. 3).
- ✓ You have read and understood the general notes on startup and operation (p. 13).

Starting up and operating the P-725

- Follow the instructions in the user manual of the piezo controller used for startup and operation of the P-725.

Discharging the P-725

The P-725 must be discharged before demounting. Demounting is necessary e.g., before cleaning or transporting the P-725 as well as for modifications

Discharging a P-725 that is connected to the controller

In closed-loop operation:

1. Switch off the servo mode on the controller.
2. Set the piezo voltage to 0 V on the controller.

In open-loop operation:

- Set the piezo voltage to 0 V on the controller.

Discharging a P-725 that is not connected to the controller

- Connect the P-725 to the switched-off PI controller for 10 seconds.

Maintenance

NOTICE



Misalignment from loosening screws on the base body!

The P-725 is maintenance-free and precisely aligned.

- Only loosen screws according to the instructions in this manual.
- Do **not** open the P-725.

Cleaning the P-725

Requirements

- ✓ You have discharged the piezo actuators of the P-725.
- ✓ You have disconnected the P-725 from the controller.

Cleaning the P-725

- Clean the surface of the P-725 with a cloth that is lightly dampened with a mild cleanser or disinfectant (e.g., ethanol or isopropyl alcohol).
- Do **not** do any ultrasonic cleaning.

Customer Service

For inquiries and orders, contact your PI sales engineer or send us an email (info@pi.ws).

- If you have questions concerning your system, have the following information ready:
 - Product and serial numbers of all products in the system
 - Firmware version of the controller (if present)
 - Version of the driver or the software (if present)
 - Operating system on the PC (if present)
- If possible: Take photographs or make videos of your system that can be sent to our customer service department if requested.

The latest versions of the user manuals are available for download on our website (www.pi.ws).

Technical Data

P-725 PIFOC Long-Travel Objective Scanner

Model	P-725.1CL P-725.1CD P-725.1CA	P-725.2CL P-725.2CD P-725.2CA	P-725.4CL P-725.4CD P-725.4CA	P-725.x0L open-loop version	Unit	Tolerance
Active axes	Z	Z	Z	Z		
Motion and positioning						
Integrated sensor	Capacitive	Capacitive	Capacitive	-		
Open-loop travel, -20 to +120V	150	330	460	as P-725.xCL	µm	min. (+20 %/ -0 %)
Closed-loop travel	100	250	400	-	µm	calibrated
Open-loop resolution	0.3	0.4	0.5	as P-725.xCL	nm	typ.
Closed-loop resolution	0.65	0.75	1.25	-	nm	typ.
Linearity, closed-loop	0.03	0.03	0.03	-	%	typ.
Repeatability	±5	±5	±5	-	nm	typ.
Runout θ_x	1	6	10	as P-725.xCL	µrad	typ.
Runout θ_y	20	45	45	as P-725.xCL	µrad	typ.
Crosstalk in X	20	20	60	as P-725.xCL	nm	typ.
Crosstalk in Y	20	40	60	as P-725.xCL	nm	typ.
Mechanical properties						
Stiffness in motion direction	0.23	0.17	0.12	as P-725.xCL	N/µm	±20 %
Unloaded resonant frequency	470	330	230	as P-725.xCL	Hz	±20 %
Resonant frequency at 150 g	185	140	120	as P-725.xCL	Hz	±20 %

Model	P-725.1CL P-725.1CD P-725.1CA	P-725.2CL P-725.2CD P-725.2CA	P-725.4CL P-725.4CD P-725.4CA	P-725.x0L open-loop version	Unit	Tolerance
Push/pull force capacity in motion direction	100 / 20	100 / 20	100 / 20	as P-725.xCL	N	max.
Drive properties						
Ceramic type	PICMA® P-885	PICMA® P-885	PICMA® P-885	as P-725.xCL		
Electrical capacitance	4.2	6.2	6.2	as P-725.xCL	µF	±20 %
Dynamic operating current coefficient	5.2	3.1	1.9	as P-725.xCL	µA / (Hz x µm)	±20 %
Miscellaneous						
Operating temperature range*	-20 to 80	-20 to 80	-20 to 80	-20 to 80	°C	
Material	Aluminum	Aluminum	Aluminum	Aluminum		
Max. objective diameter	39	39	39	39	mm	
Mass	0.215	0.23	0.23	as P-725.xCL	kg	±5 %
Sensor / voltage connection	CL-version: LEMO Others: Sub-D 7W2 (m)	CL-version: LEMO Others: Sub-D 7W2 (m)	CL-version: LEMO Others: Sub-D 7W2 (m)	LEMO (no sensor)		

*Specifications assured from 17° C to 23° C. The piezo scanner has to be recalibrated for temperatures outside this range.

P-725.xDD Fast PIFOC High-Dynamics Piezo Scanner

	P-725.CDD	P-725.SDD	Unit	Tolerance
Active axes	Z	Z		
Motion and positioning				
Integrated sensor	Capacitive	SGS		
Open-loop travel, -20 to +120 V	18	18	µm	min. (20 % / -0 %)
Closed-loop travel	18	18	µm	
Open-loop resolution	0.2	0.2	nm	typ.
Closed-loop resolution	0.2	0.2	nm	typ.
Closed-loop linearity error	0.04	0.5	%	typ.
Repeatability	±1.5	±5	nm	typ.
Runout θ_x, θ_y	2	2	µrad	typ.
Crosstalk in X, Y	150	150	nm	typ.
Mechanical properties				
Stiffness in motion direction	1.5	1.5	N/µm	±20 %
Resonant frequency, no load	1180	1180	Hz	±20 %
Resonant frequency, under load, at 200 g	450	450	Hz	±20 %
Push / pull force capacity in motion direction	100 / 20	100 / 20	N	max.
Drive properties				
Ceramic type	PICMA® P-887	PICMA® P-887		
Electrical capacitance	3.1	3.1	µF	±20 %
Dynamic operating current coefficient	19.4	19.4	µA / (Hz × µm)	±20 %
Miscellaneous				
Operating temperature range*	-20 to 80	-20 to 80	°C	
Material	Aluminum	Aluminum		
Mass	0.21	0.2	kg	±5 %
Cable length	1.5	1.5	m	±10 mm
Sensor / voltage connection	Sub-D 7W2 (m)	LEMO		

*Specifications assured from 17 °C to 23 °C. The piezo scanner has to be recalibrated for temperatures outside this range.

Dimensions

Dimensions in mm. Note that the decimal places are separated by a comma in the drawings.

P-725.xCD, P-725.xCL, P-725.x0L

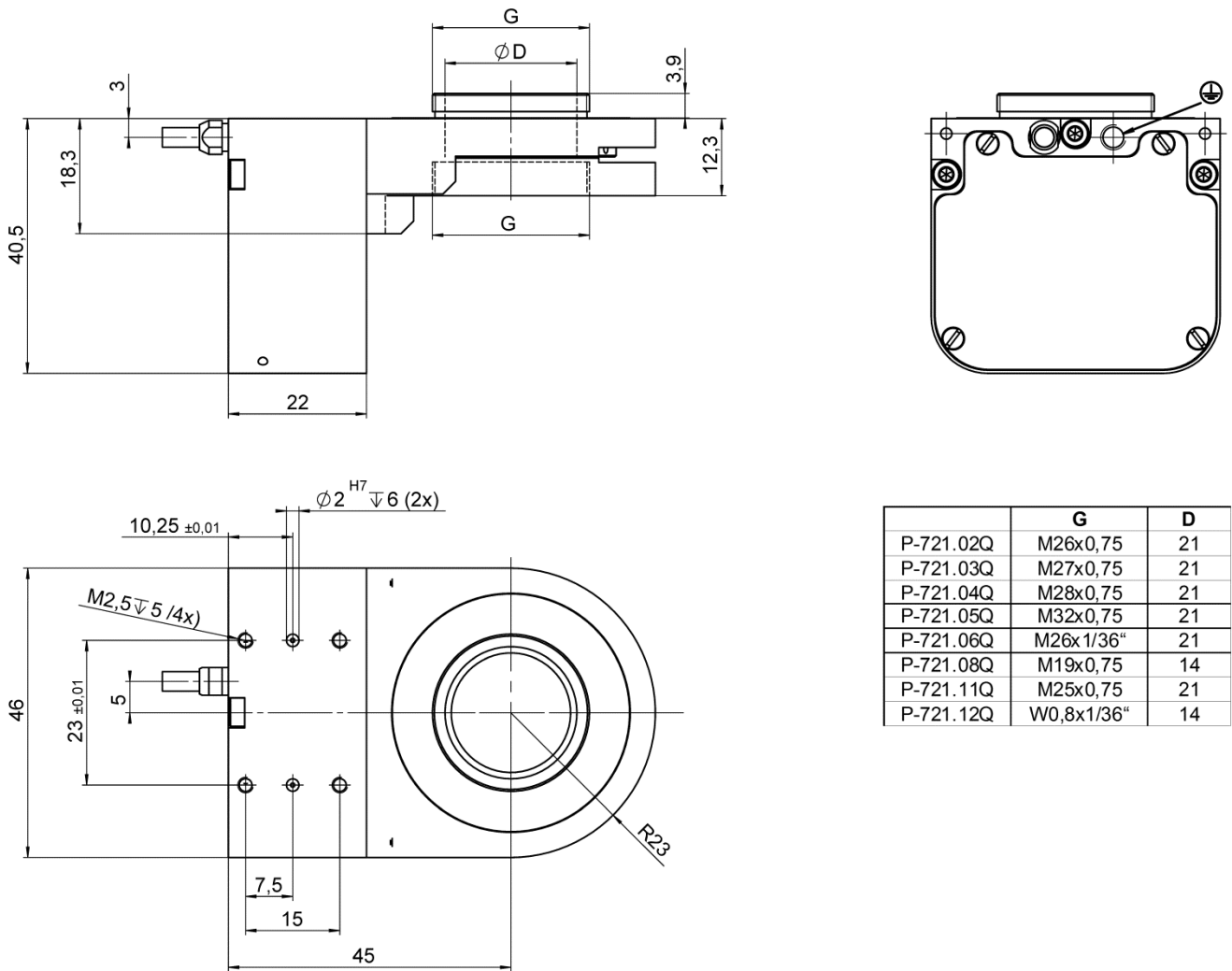

Figure 6: P-725.xCD, P-725.xCL, P-725.x0L (P-721.xxQ adapter to be ordered separately)

P-725.xCA

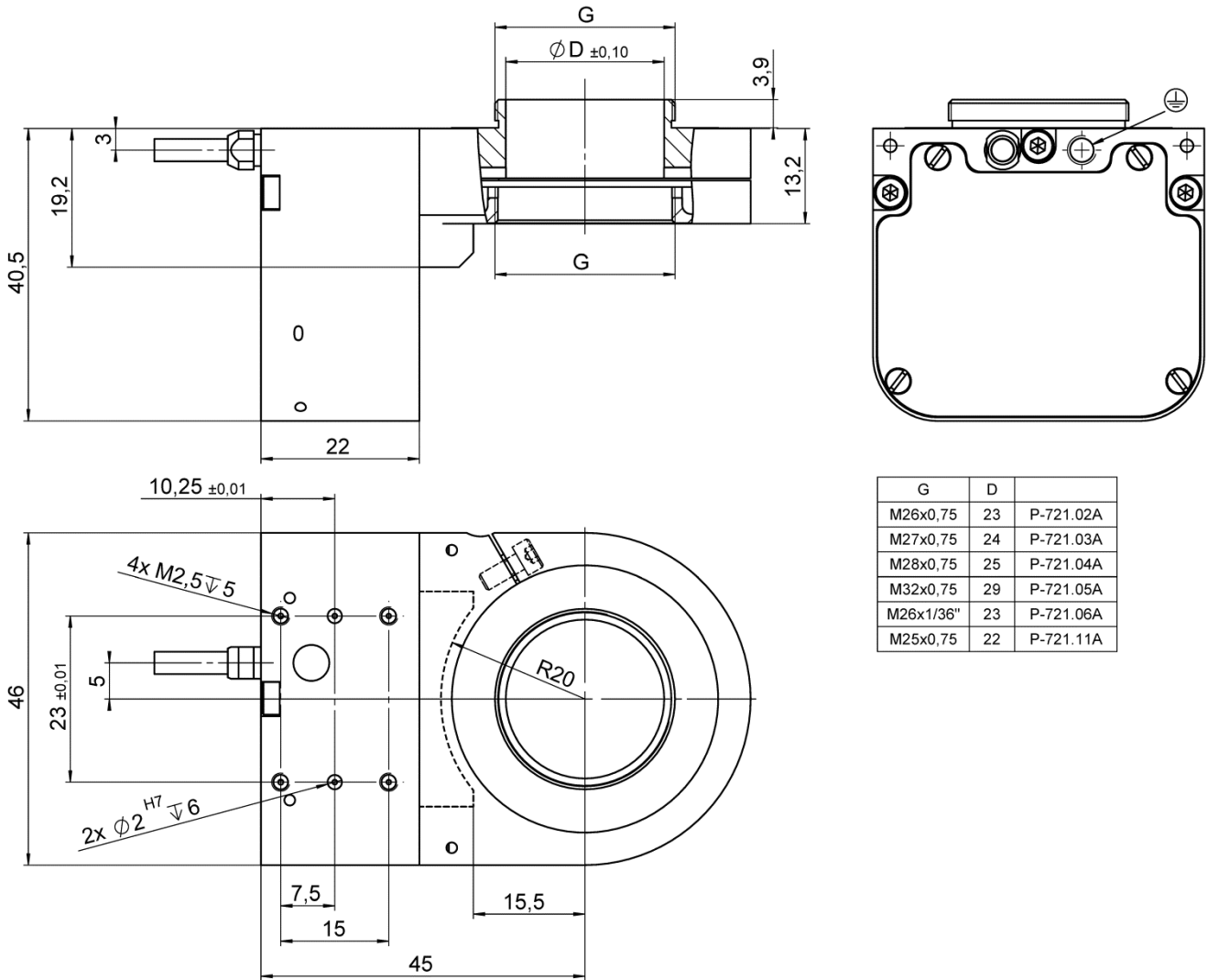

Figure 7: P-725.xCA (P-721.xx adapter to be ordered separately)

P-725.xDD

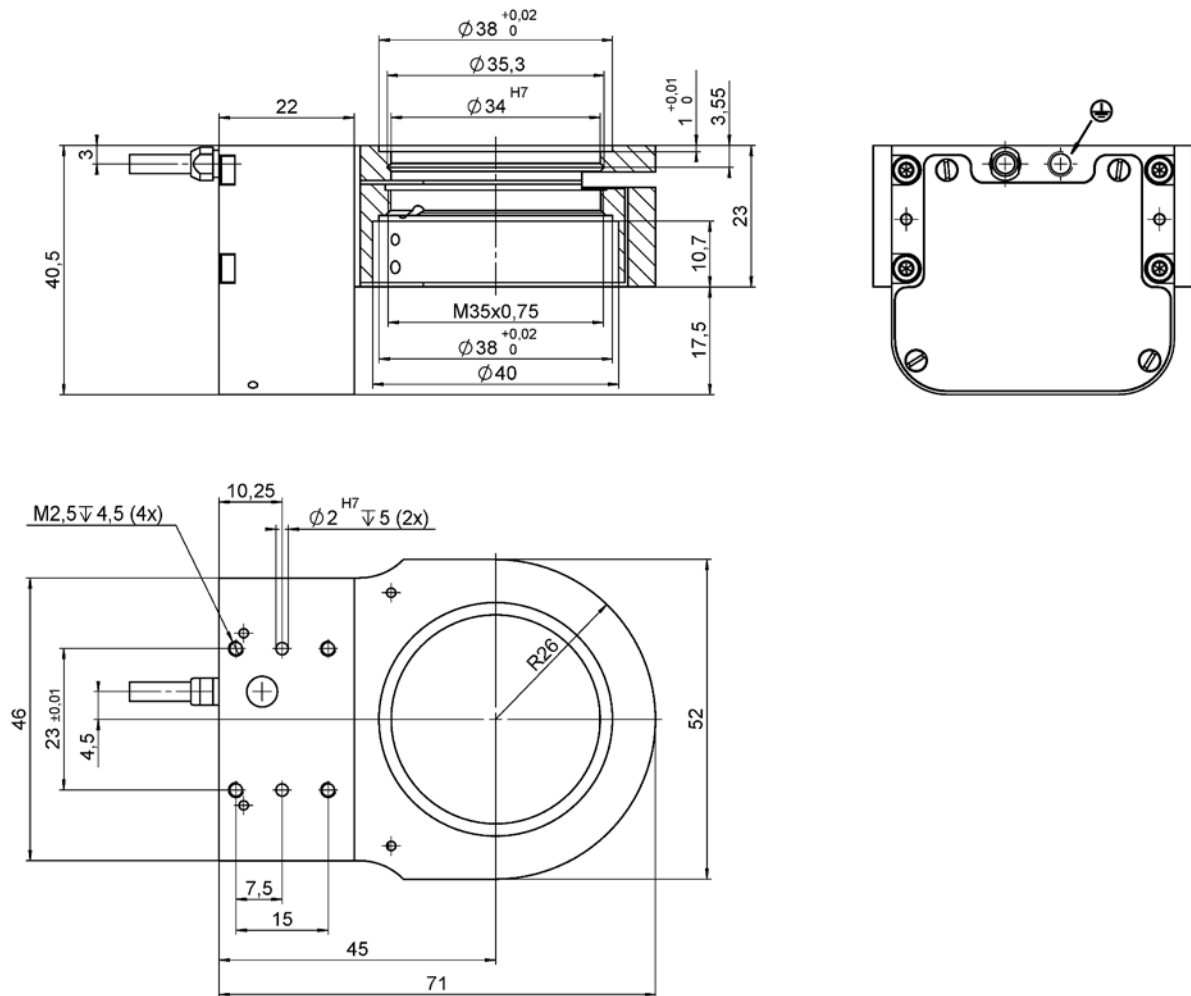

Figure 8: P-725.xDD

Pin Assignments

P-725.xCL, P-725.x0L

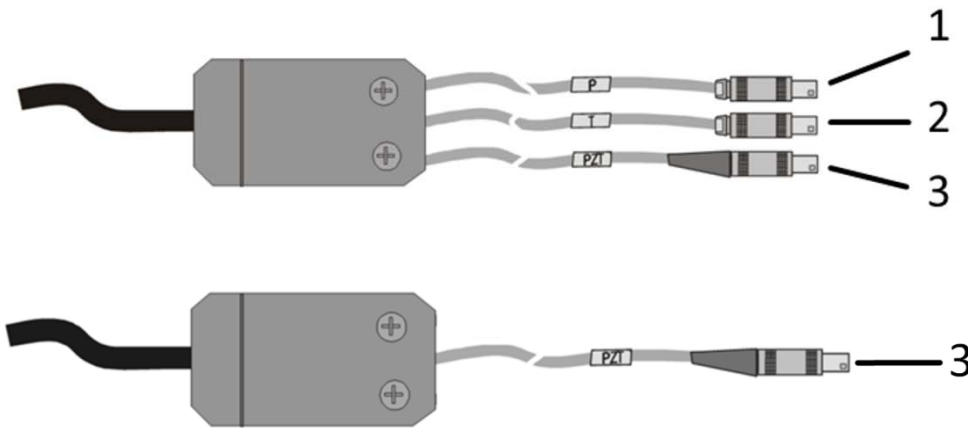

Figure 9: LEMO connectors of P-725.xCL (top) and P-725.x0L (bottom)

- 1 LEMO coaxial connector for capacitive sensor (Probe)
- 2 LEMO coaxial connector for capacitive sensor (Target)
- 3 LEMO coaxial connector for piezo voltage

LEMO coaxial connectors

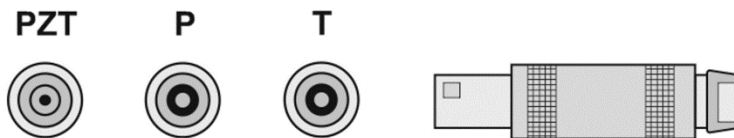

Figure 10: LEMO coaxial connectors

Connector	Signal	Function	Connector shell
P	Probe	Probe sensor signal (moving part of the capacitive sensor)	Cable shield
T	Target	Target sensor signal (non-moving part of the capacitive sensor)	Cable shield
PZT	PZT	Piezo voltage	Ground of piezo voltage on cable shield

P-725.SDD

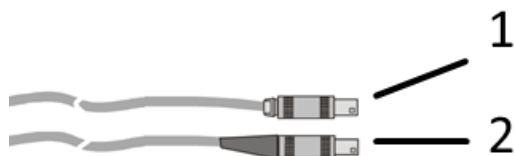

Figure 11: LEMO connectors of P-725.SDD

- 1 4-pin LEMO connector for strain gauge sensor
- 2 LEMO coaxial connector for piezo voltage

Sensor connector



Figure 12: Sensor connector, front view

Pin	Function
1	Reference (5 V)
2	Sensor -
3	Sensor +
4	GND

PZT connector

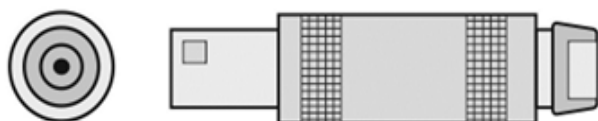

Figure 13: PZT connector, front view (left)

Pin	Function
Inner contact	PZT + (-20 to 120 V)
Connector shell	PZT - (GND)

P-725.xCD, P-725.xCA, P-725.CDD





Figure 14: Sub-D 7W2 (m) connector, front view

Pin	Signal	Function
A1 inner conductor	Input	Piezo voltage +
A2 inner conductor	Output	Probe sensor signal (nonmoving part of the capacitive sensor)
A2 outer conductor	GND	Shield
1	Bidirectional	Data line for ID chip
2	GND	Shield of Target Ground of ID chip when switched on
3	Input	Piezo voltage –
4	N.C.	Not connected
5	Input	Target sensor signal (movable part of the capacitive sensor)

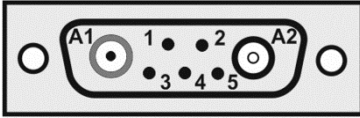
The connector shell is connected to the cable shield.

Maximum Ratings

The P-725 is designed for the following maximum ratings:

Model	Maximum operating voltage 	Maximum operating frequency (unloaded) 	Maximum power consumption 
P-725.1xx	-20 to 120 V	150 Hz	13 W
P-725.2xx	-20 to 120 V	100 Hz	17.4 W
P-725.4xx	-20 to 120 V	75 Hz	17.4 W
P-725.xDD	-20 to 120 V	300 Hz	4.7 W

Ambient Conditions and Classifications

The following ambient conditions and classifications must be observed for the P-725:

Area of application	For indoor use only
Maximum altitude	2000 m
Air pressure	1100 hPa to 1013 hPa
Relative humidity	Highest relative humidity 80 % for temperatures up to 31 °C Decreasing linearly to 50 % relative humidity at 40 °C
Storage temperature	-20 °C to 80 °C
Transport temperature	-25 °C to 85 °C
Overvoltage category	II
Protection class	I
Degree of pollution	1
Degree of protection according to IEC 60529	IP20

Old Equipment Disposal

In accordance with EU law, electrical and electronic equipment may not be disposed of in EU member states via the municipal residual waste.

Dispose of your old equipment according to international, national, and local rules and regulations. In order to fulfil its responsibility as the product manufacturer, Physik Instrumente (PI) GmbH & Co. KG undertakes environmentally correct disposal of all old PI equipment made available on the market after 13 August 2005 without charge.

Any old PI equipment can be sent free of charge to the following address:

Physik Instrumente (PI) GmbH & Co. KG
 Auf der Roemerstr. 1
 D-76228 Karlsruhe, Germany

