

## MP155E V-273 VC Linear Actuator User Manual

Version: 1.1.3

Date: 20.08.2019



### This document describes the following products:

- **V-273.440**  
PIMag® voice coil linear actuator, 20 mm, 6 N, linear encoder, 0.01  $\mu\text{m}$  resolution
- **V-273.441**  
PIMag® voice coil linear actuator, 20 mm, 6 N, linear encoder, 0.01  $\mu\text{m}$  resolution, force sensor



The following company names and brands are registered trademarks of Physik Instrumente (PI) GmbH & Co. KG:

PI<sup>®</sup>, NanoCube<sup>®</sup>, PICMA<sup>®</sup>, PILine<sup>®</sup>, NEXLINE<sup>®</sup>, PiezoWalk<sup>®</sup>, NEXACT<sup>®</sup>, Picoactuator<sup>®</sup>, Plnano<sup>®</sup>, PIMag<sup>®</sup>, Q-Motion<sup>®</sup>

Notes on brand names and third-party trademarks:

BiSS is a registered trademark of iC-Haus GmbH.

The patents held by PI are found in our patent list: <http://www.physikinstrumente.com/en/about-pi/patents>

© 2019 Physik Instrumente (PI) GmbH & Co. KG, Karlsruhe, Germany. The text, photographs, and drawings in this manual are protected by copyright. With regard thereto, Physik Instrumente (PI) GmbH & Co. KG retains all the rights. The use of any text, images and drawings is permitted only in part and only when indicating the source.

Original instructions

First printing: 20.08.2019

Document number: MP155E, KSch, Version 1.1.3

Subject to change. This manual is superseded by any new release. The latest respective release is available for download (p. 3) on our website.

# Contents

<b>1</b>	<b>About this Document</b>	<b>1</b>
1.1	Objective and Target Audience of this User Manual.....	1
1.2	Symbols and Typographic Conventions.....	1
1.3	Definition of Terms.....	2
1.4	Figures .....	3
1.5	Other Applicable Documents .....	3
1.6	Downloading Manuals.....	3
<b>2</b>	<b>Safety</b>	<b>5</b>
2.1	Intended Use .....	5
2.2	General Safety Instructions .....	5
2.3	Organizational Measures.....	5
<b>3</b>	<b>Product Description</b>	<b>7</b>
3.1	Model Overview .....	7
3.2	Product View .....	7
3.2.1	Overview.....	7
3.2.2	Product Details .....	8
3.2.3	Product Labeling.....	10
3.3	Scope of Delivery.....	11
3.4	Suitable Controllers .....	11
3.5	Technical Features.....	12
3.5.1	Linear Encoder .....	12
3.5.2	Reference Switch .....	12
3.5.3	Force Sensor .....	12
3.5.4	Adapter with ID Chip for Connecting to the C-413.2xx Controller.....	12
3.5.5	Guiding.....	13
<b>4</b>	<b>Unpacking</b>	<b>15</b>
<b>5</b>	<b>Installation</b>	<b>17</b>
5.1	General Notes on Installation.....	17
5.2	Optional: Changing the Contact Part of the Force Sensor on the V-273.441 .....	19
5.3	Installing the V-273 into a Mechanical Mounting .....	20
5.4	Connecting the V-273 to the Controller .....	23

<b>6</b>	<b>Startup and Operation</b>	<b>25</b>
6.1	General Notes on Startup and Operation .....	25
6.2	Temperature Dependency of the Nominal Current: Calculating the Nominal Current.....	28
6.3	Starting Up the V-273 with the C-413 Controller .....	29
<b>7</b>	<b>Maintenance</b>	<b>31</b>
7.1	General Notes on Maintenance .....	31
7.2	Preparing the V-273 for Transport .....	31
7.3	Cleaning the V-273 .....	32
<b>8</b>	<b>Troubleshooting</b>	<b>33</b>
<b>9</b>	<b>Customer Service</b>	<b>35</b>
<b>10</b>	<b>Technical Data</b>	<b>37</b>
10.1	Specifications.....	37
10.1.1	Data Table.....	37
10.1.2	Maximum Ratings.....	38
10.1.3	Ambient Conditions and Classifications .....	39
10.1.4	Reference Switch Specifications.....	39
10.2	Dimensions .....	40
10.2.1	V-273.440 .....	40
10.2.2	V-273.441 .....	41
10.3	Pin Assignment .....	43
10.3.1	Motor and Position Sensor Connector .....	43
10.3.2	V901B0030 Adapter.....	44
10.3.3	V-273.441: Force Sensor Connector.....	45
<b>11</b>	<b>Old Equipment Disposal</b>	<b>47</b>
<b>12</b>	<b>EU Declaration of Conformity</b>	<b>49</b>

# 1 About this Document

## In this Chapter

Objective and Target Audience of this User Manual .....	1
Symbols and Typographic Conventions .....	1
Definition of Terms .....	2
Figures.....	3
Other Applicable Documents.....	3
Downloading Manuals .....	3

### 1.1 Objective and Target Audience of this User Manual

This manual contains information on the intended use of the V-273.

It assumes that the reader has a fundamental understanding of basic servo systems as well as motion control concepts and applicable safety procedures.

The latest versions of the user manuals are available for download (p. 3) on our website.

### 1.2 Symbols and Typographic Conventions

The following symbols and typographic conventions are used in this user manual:

#### **DANGER**



**Imminently hazardous situation**

If not avoided, the hazardous situation will result in death or serious injury.



- Actions to take to avoid the situation

#### **CAUTION**



**Dangerous situation**

Failure to comply could lead to minor injury.



- Precautionary measures for avoiding.

**NOTICE**



**Dangerous situation**

Failure to comply could cause damage to equipment.

- Precautionary measures for avoiding.

**INFORMATION**

Information for easier handling, tricks, tips, etc.

Symbol/ Label	Meaning
1. 2.	Action consisting of several steps whose sequential order must be observed
➤	Action consisting of one or several steps whose sequential order is irrelevant
▪	Lists
p. 5	Cross-reference to page 5
RS-232	Labeling of an operating element on the product (example: socket of the RS-232 interface)
	Warning sign affixed to the product that refers to detailed information in this manual.

**1.3 Definition of Terms**

Term	Explanation
VC linear actuator / VC linear drive	VC = Voice Coil The feed is generated by the Lorentz force on an energized coil (PIMag® principle) that couples to a runner. The V-273 thus combines a relatively long travel range with a high velocity and a high resolution.
Max. push/pull force	Maximum force in the direction of motion. Position or velocity control: When a counterforce is exerted on the linear actuator, the linear actuator counteracts it with maximum force to maintain the target position or target velocity. When the counterforce exceeds the specified value of the push/pull force (p. 37), displacements or changes in velocity can occur.

Term	Explanation
Max. push/pull force	<p>Force control:</p> <p>When a counterforce is exerted on the linear actuator, the linear actuator maximally counteracts it with the target force value. If the counterforce exceeds the target force value, displacements are possible.</p> <p>When the servo mode is switched off, the weight force of the moving mass can be compensated for by an AutoZero procedure (see user manual of the C-413 controller).</p>
Incremental position sensor	<p>Sensor (encoder) for capturing changes of position or changes of angle. Signals from the incremental position sensor are used for axis position feedback. After the controller is switched on, a reference point definition must be performed before absolute target positions can be commanded and reached.</p>

## 1.4 Figures

For better understandability, the colors, proportions, and degree of detail in illustrations can deviate from the actual circumstances. Photographic illustrations may also differ and must not be seen as guaranteed properties.

## 1.5 Other Applicable Documents

The devices and software tools from PI mentioned in this documentation are described in their own manuals.

Product	Document
C-413 PIMag® Controller	MS224E User Manual
PIMikroMove	SM148E Software Manual

## 1.6 Downloading Manuals

### **INFORMATION**

If a manual is missing or problems occur with downloading:

- Contact our customer service department (p. 35).

### **INFORMATION**

For products that are supplied with software (CD in the scope of delivery), access to the manuals is protected by a password. Protected content is only displayed on the website after entering the access data.

You need the product CD to get the access data.

### For products with CD: Get access data

1. Insert the product CD into the PC drive.
2. Switch to the Manuals directory on the CD.
3. In the Manuals directory, open the Release News (file including *releasenews* in the file name).
4. Get the access data for downloading protected content in the "User login for software download" section of the Release News. Possible methods for getting the access data:
  - Link to a page for registering and requesting the access data
  - User name and password is specified
5. If the access data needs to be requested via a registration page:
  - a) Follow the link in the Release News.
  - b) Enter the required information in the browser window.
  - c) Click **Show login data** in the browser window.
  - d) Note the user name and password shown in the browser window.

### Downloading manuals

If you have requested access data for protected contents via a registration page (see above):

- Click the links in the browser window to change to the content for your product and log in using the access data that you received.

General procedure:

1. Open the website **www.pi.ws**.
2. If access to the manuals is protected by a password:
  - a) Click **Login**.
  - b) Log in with the user name and password.
3. Click **Search**.
4. Enter the product number up to the period (e.g., C-413) into the search field.
5. Click **Start search** or press the  key.
6. Open the corresponding product detail page in the list of search results:
  - a) If necessary: Scroll down the list.
  - b) If necessary: Click **Load more results** at the bottom of the list.
  - c) Click the corresponding product in the list.
7. Click the **Downloads** tab.

The manuals are shown under **Documentation**.
8. Click the desired manual and save it to the hard disk of your PC or to a data storage medium.



## 2 Safety

### In this Chapter

Intended Use.....	5
General Safety Instructions.....	5
Organizational Measures.....	5

### 2.1 Intended Use

The V-273 is a laboratory device as defined by DIN EN 61010-1. It is intended for indoor use and use in an environment which is free of dirt, oil, and lubricants.

The V-273 has a VC linear drive (p. 2), a position sensor and, depending on the model, a force sensor as well. The V-273 is intended for positioning, adjusting and shifting loads in one axis at various velocities and with defined forces.

The V-273 is a linear actuator for applications in automation or handling technology. The V-273 is not intended for applications in areas in which a failure would present severe risks to human beings or the environment.

The intended use of the V-273 is only possible when installed and in conjunction with a suitable controller (p. 11). The controller is not included in the scope of delivery of the V-273.

### 2.2 General Safety Instructions

The V-273 is built according to state-of-the-art technology and recognized safety standards. Improper use can result in personal injury and/or damage to the V-273.

- Use the V-273 for its intended purpose only, and only when it is in perfect technical condition.
- Read the user manual.
- Eliminate any malfunctions that may affect safety immediately.

The operator is responsible for the correct installation and operation of the V-273.

### 2.3 Organizational Measures

#### User manual

- Keep this user manual with the V-273 always.  
The latest versions of the user manuals are available for download (p. 3) on our website.

- Add all information given by the manufacturer to the user manual, for example supplements or technical notes.
- If you give the V-273 to other users, also include this user manual as well as other relevant information provided by the manufacturer.
- Always work according to the complete user manual. If your user manual is incomplete and is therefore missing important information, damage to equipment can result.
- Install and operate the V-273 only after you have read and understood this user manual.

### **Personnel qualification**

The V-273 may only be installed, started up, operated, maintained, and cleaned by authorized and appropriately qualified personnel.

# 3 Product Description

## In this Chapter

Model Overview..... 7  
 Product View..... 7  
 Scope of Delivery ..... 11  
 Suitable Controllers ..... 11  
 Technical Features ..... 12

### 3.1 Model Overview

Two standard versions of the V-273 linear actuator are available. They differ with regard to the force sensor and therefore the dimensions.

Model	Dimension	Force sensor present?
V-273.440	200 mm x 53 mm x 37.2 mm	No
V-273.441	205.5 mm x 53 mm x 37.2 mm	Yes

➤ For further technical data, see the specifications (p. 37).

### 3.2 Product View

#### 3.2.1 Overview



Figure 1: V-273.440 (left) and V-273.441 (right)

3.2.2 Product Details

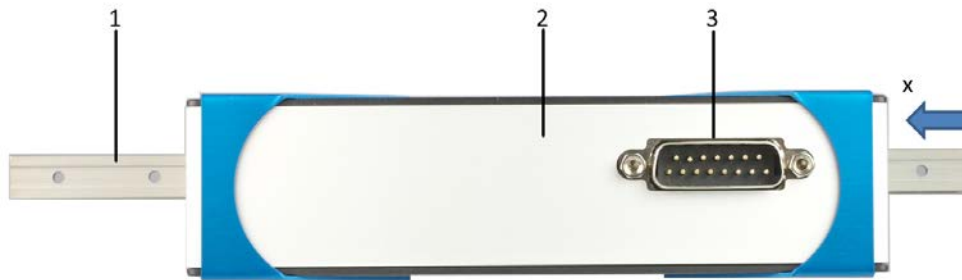

Figure 2: Front side of the linear actuator, here V-273.440

- 1 Runner (= guide rail)
- 2 Housing
- 3 Connector for motor cable (panel plug, Sub-D 15)
- x Positive direction of motion

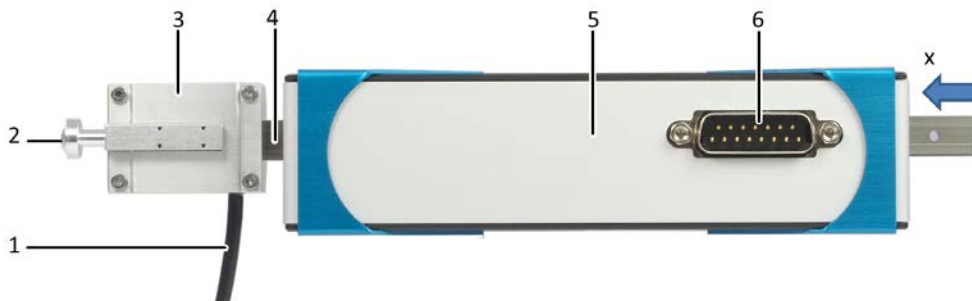

Figure 3: Front side of the linear actuator, here V-273.441

- 1 Cable exit of the force sensor
- 2 Exchangeable contact part of the force sensor
- 3 Force sensor
- 4 Runner (= guide rail)
- 5 Housing
- 6 Connector for motor cable (panel plug, Sub-D 15)
- x Positive direction of motion



Figure 4: V901B0030 adapter for connecting the motor cable

- 1 Connector for motor cable (socket, Sub-D 15)
- 2 Connector for controller (connector, Sub-D 15)



Figure 5: Force sensor

- 1 M3 threaded bolt for screwing the contact part onto the force sensor

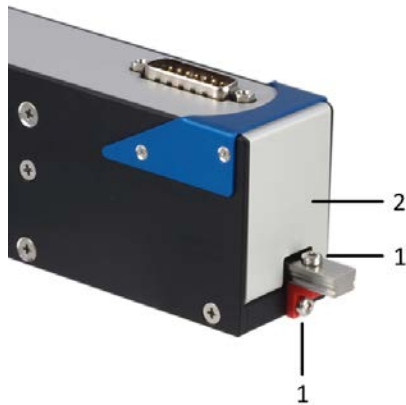

Figure 6: Transport safeguard on the side of the linear actuator V-273.44x, hole pattern and the transport safeguard are identical for the V-273.440 and V-273.441

- 1 Transport safeguard (bracket with 2 M3x8 screws)
- 2 Housing

### 3.2.3 Product Labeling

On the housing of the V-273, there is a type plate with the following information:

Labeling	Description
	Data matrix code (example; contains the serial number)
V-273.440	Product name (example), the characters following the period refer to the model
116003601	Serial number (example), individual for each V-273 Meaning of each position (from the left): 1 = internal information, 2 and 3 = year of manufacture, 4 to 9 = consecutive number
	Manufacturer's logo
	Warning sign "Pay attention to the manual!"
	Warning sign "Magnetic field"
	Prohibition sign for heart pacemakers, defibrillators, and other active implants
	Warning sign „Risk of crushing“
	Old equipment disposal (p. 47)
Country of origin: Germany	Country of origin
WWW.PI.WS	Manufacturer's address (website)
	CE conformity mark

**V901B0030: Labeling of the Sub-D 15 (m/f) adapter**

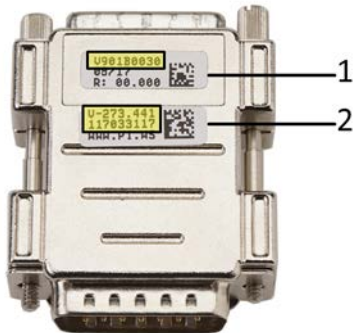

Figure 7: Product labeling of the V901B0030 adapter

- 1 Label with product name of the adapter
- 2 Label with product name and serial number of the actuator for which the adapter is intended

**3.3 Scope of Delivery**

Item number	Component
V-273	Linear actuator according to order (p. 7)
V273E0023	Transport safeguard consisting of: <ul style="list-style-type: none"> <li>▪ 1 bracket, 9.5 mm x 6 mm</li> <li>▪ 2 screws, A2 M3x8, ISO 4762</li> </ul>
V901B0030	Sub-D 15 (m/f) adapter for connecting the motor cable
K030B0853	Sub-D 15 (m/f) motor cable, 1,5 m
MP162EK	Short instructions in printed form

**3.4 Suitable Controllers**

The V-273 must be connected to a suitable controller. The following controllers from PI are suitable for the operation of the V-273:

Controller	Description
C-413.20	PIMag® motion controller, 2 channels, OEM board, USB and SPI interface, force control option
C-413.20A	PIMag® motion controller, 2 channels, OEM board, USB and SPI interface, analog inputs, force control option
C-413.2G	PIMag® motion controller, 2 channels, benchtop device, USB and SPI interface, force control option
C-413.2GA	PIMag® motion controller, 2 channels, benchtop device, USB and SPI interface, analog inputs, force control option

PC software is included in the scope of delivery of the controllers from PI. The operation of the controllers is described in the corresponding user manuals.

### 3.5 Technical Features

#### 3.5.1 Linear Encoder

The V-273 is equipped with an optical linear encoder. For the resolution, refer to the table in the "Specifications" section (p. 37).

Optical linear encoders measure the actual position directly (direct metrology). Therefore, errors occurring in the drivetrain such as nonlinearity, backlash or elastic deformation, cannot influence the measurement of the position.

#### 3.5.2 Reference Switch

The V-273 is equipped with a direction-sensing reference switch, which is located at about the midpoint of the travel range. This sensor transmits a TTL signal that indicates whether the linear actuator is on the positive or negative side of the reference switch.

See the controller user manual and/or associated software manuals for the commands that make use of the reference point signal.

For more information, see "Reference Switch Specifications" (p. 39).

#### 3.5.3 Force Sensor

The V-273.441 is equipped with a force sensor. The force sensor is mounted on the runner (p. 8).

The force sensor allows application of a defined force and measurement of the counterforce that is applied orthogonally to the contact part of the sensor (p. 20). Forces up to 10 N can be measured and forces up to 6 N can be applied, each with an open-loop resolution of 1 mN.

The force sensor works as an incremental sensor. When the controller is switched on or rebooted, the connected force sensor always measures 0 N, regardless of the actual force exerted on the force sensor.

#### 3.5.4 Adapter with ID Chip for Connecting to the C-413.2xx Controller

The V901B0030 adapter is adapted at the factory to the V-273 to achieve optimum positioning accuracy.

The adapter has an ID chip on which the following data is stored:

- Information on the linear actuator:
  - Type
  - Serial number
- Coefficients of the polynomial for mechanics linearization
- Settings for the sensor: E.g. interpolation rate, corrections of hysteresis, phase and offset, gain values



- Data for checking the validity when the contents of the ID chip are read out
- When switched on or rebooted, controllers from PI read the data from the ID chip.  
For more information on the ID chip recognition, see the manual of the controller used.

#### ***INFORMATION***

The V901B0030 adapter must not be used if a controller other than a PI controller is to be used.

In addition, the following conditions must be met by the controller:

- It can process differential sin/cos encoder signals.
- It has digital inputs for the differential signals of the reference switch of the linear actuator.
- It can operate 1-phase DC motors with  $\pm 1.5$  A.

#### **3.5.5 Guiding**

The V-273.44x models are equipped with a recirculating ball bearing. This makes the motion of the runner insensitive to lateral forces and torques.



## 4 Unpacking

### NOTICE



#### Mechanical overload from incorrect handling!

An impermissible mechanical load on the V-273 due to transportation without a transport safeguard and incorrect handling, can damage the runner of the V-273 as well as cause loss of accuracy.

- Only ship the V-273 in the original packaging and with the transport safeguard attached.
- Only hold the V-273 by the housing

The V-273 is delivered with a transport safeguard attached.

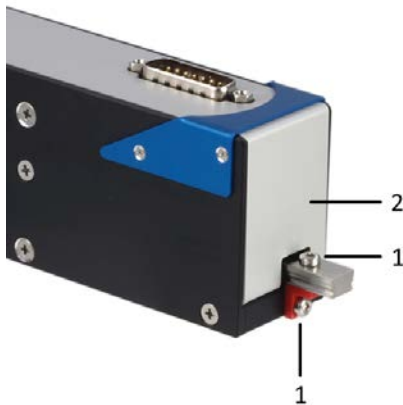

Figure 8: Transport safeguard on the side of the linear actuator V-273.44x, hole pattern and the transport safeguard are identical for the V-273.440 and V-273.441

- 1 Housing
- 2 Transport safeguard (bracket with 2 M3x8 screws)

### Tools and accessories

- Hex key AF 2.5

### Unpacking the V-273

1. Unpack the V-273 with care.
2. Compare the contents with the items listed in the contract and the packing list. If parts are incorrectly supplied or missing, contact PI immediately.
3. Inspect the contents for signs of damage. If you notice signs of damage, contact PI immediately.

4. Remove the transport safeguard:
  - a) Loosen and remove both M3 screws.
  - b) Remove the bracket.
5. Keep all packaging materials and the transport safeguard in case the product needs to be transported later.

## 5 Installation

### In this Chapter

General Notes on Installation .....	17
Optional: Changing the Contact Part of the Force Sensor on the V-273.441.....	19
Installing the V-273 into a Mechanical Mounting .....	20
Connecting the V-273 to the Controller .....	23

### 5.1 General Notes on Installation

#### **DANGER**



#### **Strong magnetic fields affect heart pacemakers!**

The V-273 contains permanent magnets that could impair the function of heart pacemakers and other active implants. **The magnetic fields are also effective when the V-273 is not connected to the controller/electric power.**

- Make sure that people with heart pacemakers and / or other active implants do not have access to the V-273.
- Ensure that hazardous areas are marked correspondingly.

#### **CAUTION**



#### **Risk of cuts and crushing!**

The V-273 linear actuator can generate high forces at high velocities. When a contact part with a small contact surface is installed on the runner of the linear actuator, the pressure exerted by the runner on a fixed part or obstacle during operation may be very high. If fingers or limbs get caught between the runner of the linear actuator and a fixed part or obstacle during operation, there is a risk of minor injury from cuts and crushing.

- Use protective structures to keep limbs away from areas in which they could be caught by moving parts.
- Observe the safety distances in accordance with the applicable standards when installing protective structures.
- If possible, use contact parts with a sufficiently dimensioned contact area, so that a pressure of 50 N / cm<sup>2</sup> is not exceeded when operating the linear actuator with the maximum specified force (p. 37).

**NOTICE****Heating up of the V-273 during operation!**

The heat produced during operation of the V-273 can affect your application.

- Install the V-273 so that the application is not affected by the dissipated heat.
- Ensure sufficient ventilation at the place of installation.
- Make sure that the complete bottom side of the V-273 is in contact with the surface on which the V-273 is mounted.

**NOTICE****Attraction of magnetizable objects!**

The magnets in the V-273 can attract magnetizable objects such as loose screws. Objects attracted can damage the V-273.

- Make sure that there are no movable, magnetizable objects within a radius of at least 10 cm around the housing of the V-273.
- Apply corresponding precautions also for storage and transport of the V-273.

**NOTICE****Damage to magnetically sensitive objects!**

The magnets in the V-273 can damage magnetically sensitive objects such as magnetic data carriers and electronic devices.

- Make sure that there are no magnetically sensitive objects within a radius of at least 10 cm around the housing of the V-273.
- Apply corresponding precautions also for storage and transport of the V-273.

**NOTICE****Damage due to collisions!**

Collisions can damage the linear actuator, the load to be moved, and the surroundings.

- Make sure that no collisions are possible between the linear actuator, the load to be moved, and the surroundings in the motion range of the linear actuator.

**NOTICE****Lubricants, dirt, condensation!**

Dirt, oil, lubricants and condensation will render the motor/drive inoperable.

- Keep the V-273 free from lubricants.
- Keep the V-273 free from dirt and condensation.

**INFORMATION**

If unsuitable cables are used, interference can occur in the signal transmission between the linear actuator and the controller.

- Only use original PI parts to connect the linear actuator to the controller. The maximum cable length is **1,5 m**.
- If you need longer cables, contact our customer service department (p. 35).

**INFORMATION**

For the positive direction of motion of the runner (X axis), see "Product Details" (p. 8) or the dimensional drawing in "Dimensions" (p. 40).

## 5.2 Optional: Changing the Contact Part of the Force Sensor on the V-273.441

**INFORMATION**

The mechanical coupling of the runner to a surface is achieved using the contact part of the force sensor. A contact part made of aluminum and plastic is installed by default.

- If you change the contact part, you may have to adapt the parameter settings of the C-413 controller to the changed contact stiffness.

**Requirements**

- ✓ The linear actuator is **not** connected to the controller.

**Tools and accessories**

- Suitable contact part with M3 internal thread

**Changing the contact part of the force sensor on the V-273.441 model**

1. Manually unscrew the contact part to be changed from the force sensor of the V-273.441.
2. Manually screw the new contact part onto the M3 threaded bolt of the force sensor.  
Maximum torque: 15 Ncm.

### 5.3 Installing the V-273 into a Mechanical Mounting

#### NOTICE

**Increased friction due to lateral forces on the runner!**

Lateral forces acting on the runner of the V-273 increase the friction between the runner and internal drive components. Increased friction impairs the motion of the runner and increases wear on the drive components.

- Avoid lateral forces on the runner of the V-273.

#### NOTICE

**Excessively long screws!**

Screws inserted too deeply will damage the V-273.

- Pay attention to the maximum screw-in depth for the mounting holes (p. 40).
- Only use screws of the correct length for the respective mounting holes.

#### NOTICE

**Warping of the V-273 when mounted on uneven surfaces!**

Mounting the V-273 onto an uneven surface can warp the V-273. Warping reduces the accuracy.

- Mount the V-273 onto an even surface. The recommended evenness of the surface is  $\leq 20 \mu\text{m}$ .
- For applications with large temperature changes:  
Only mount the V-273 onto surfaces that have the same or similar thermal expansion properties as the V-273 (e.g., surfaces made of aluminum).

#### INFORMATION

V-273.440 model: The moving part of the mechanical mounting can be connected to the runner of the linear actuator.





Figure 9: V-273.440: The white arrows mark the holes for affixing the movable part of the mounting to the runner

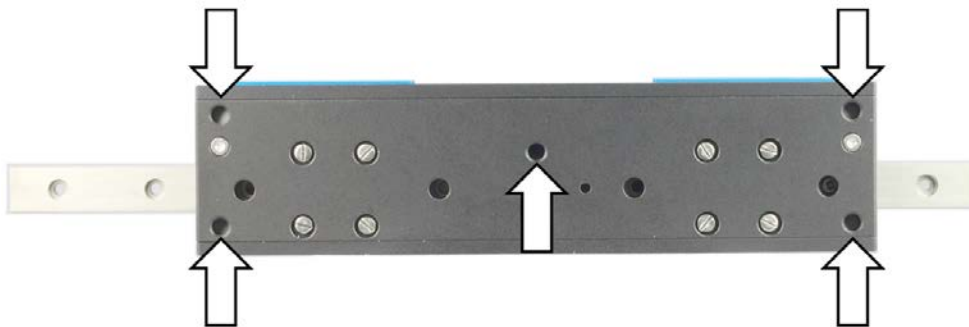

Figure 10: V-273.440: Mounting holes for mounting the V-273 onto a surface, identical for V-273.441

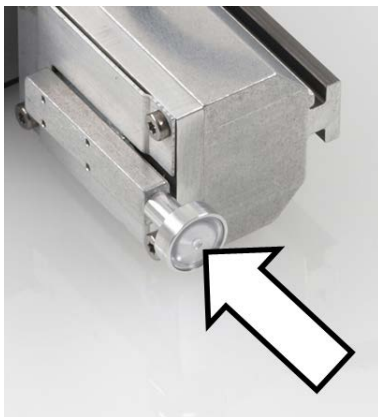

Figure 11: V-273.441: Ideally, the contact part of the force sensor is oriented orthogonally to the counterforce that is exerted on the runner and is measured

### Requirements

- ✓ You have read and understood the general notes on installation (p. 17).
- ✓ You have designed the mechanical mounting, in which the V-273 is installed, so that collisions are not possible.

- ✓ When a V-273.441 is used, the mechanical mounting also meets the following conditions:
  - When the controller is switched on or rebooted, **no** force is applied to the contact part of the connected force sensors.
  - The contact part of the force sensor (see figure) is oriented orthogonally to the counterforce that is applied to the runner.
- ✓ You have provided a suitable surface on the fixed part of the mechanical mounting for attaching the housing of the V-273:
  - At least three M4 mounting holes are present. For the required position of the holes, see "Dimensions" (p. 40).
  - The thickness of the surface, the depth of the mounting holes and counterbores, as well as the length of the screws used, are matched so that the maximum screw-in depth in the V-273 is adhered to (p. 40).
  - The flatness of the surface is  $\leq 20 \mu\text{m}$ .
  - For applications with large temperature changes:  
The surface has the same thermal expansion properties as the V-273.
- ✓ You have accounted for the space required to route cables without bending and according to regulations.
- ✓ The linear actuator is **not** connected to the controller.

#### Tools and accessories

- If the movable part of the mechanical mounting is to be connected to the runner of the V-273.440: 1 to 2 M2 screws of suitable length (see "Dimensions" (p. 40))
- 3 to 5 M4 screws of suitable length (see "Dimensions" (p. 40)) for attaching the housing of the V-273 to a surface
- Suitable tool for tightening the screws

#### Affixing the movable part of the mounting to the V-273.440 model

1. Align the runner of the linear actuator in the mounting so that the corresponding mounting holes in the mounting and the runner overlap.
2. Affix the movable part of the mounting to the holes in the runner of the V-273.
3. Check that connected parts are affixed firmly.

#### Attaching the V-273 to the fixed part of the mounting

1. Align the linear actuator or surface so that the corresponding mounting holes in linear actuator and surface overlap.
2. Screw the screws into the mounting holes on the bottom side of the surface.  
Maximum screw-in depth: 5 mm  
Maximum torque: 2.6 Nm
3. Check that the V-273 is affixed firmly to the surface.

## 5.4 Connecting the V-273 to the Controller

### INFORMATION

The V901B0030 adapter is adapted at the factory to the V-273 to achieve optimum positioning accuracy. Replacing the adapter or the V-273 leads to an incorrect positioning and may even lead to oscillation of the servo loop.

- When connecting the V-273, observe the assignment of the adapter to V-273, which is given on the label of the adapter.

### Requirements

- ✓ You have read and understood the general notes on installation (p. 17).
- ✓ The controller is switched off, i.e., **not** connected to the power supply

### Tools and accessories

- V901B0030 adapter Sub-D 15 (m/f) , in the scope of delivery (p. 11)
- K030B0853 motor cable Sub-D 15 (m/f), 1,5 m, in the scope of delivery (p. 11)
- C-413.2xx controller (p. 11)

### Connecting the V-273 to the controller

1. Connect the Sub-D 15-pin (f) connector of the adapter to the **Motor & Sensor** socket of the controller.
2. Connect the connector of the motor cable to the Sub-D 15-pin (f) socket of the adapter.
3. Connect the socket of the motor cable to the Sub-D 15-pin panel plug (m) of the linear actuator.
4. Secure the adapter and motor cable with the integrated screws against unintentional disconnection from each other or from the controller and the linear actuator.
5. When the linear actuator has a force sensor with a separate Sub-D 15 (m) connector: Connect the force sensor to the **Motor & Sensor** socket of the C-413 that is still free.



## 6 Startup and Operation

### In this Chapter

General Notes on Startup and Operation.....	25
Temperature Dependency of the Nominal Current: Calculating the Nominal Current.....	28
Starting Up the V-273 with the C-413 Controller .....	29

### 6.1 General Notes on Startup and Operation

The V-273 is started and operated with the PIMag® C-413 motion controller from PI.

#### **DANGER**



#### **Strong magnetic fields affect heart pacemakers!**

The V-273 contains permanent magnets that could impair the function of heart pacemakers and other active implants. **The magnetic fields are also effective when the V-273 is not connected to the controller/electric power.**

- Make sure that people with heart pacemakers and / or other active implants do not have access to the V-273.
- Ensure that hazardous areas are marked correspondingly.

#### **NOTICE**



#### **Overheating caused by unfavorable nominal current!**

The nominal current in the data table (p. 37) only applies when operating at room temperature. The nominal current needed for operating the actuator must be adjusted when the ambient temperature rises. Otherwise the actuator could be damaged by overheating.

- Calculate the nominal current according to the ambient temperature (p. 28).
- Adapt your application (acceleration, velocity, load) so that the calculated nominal current is not exceeded. If you have any questions, contact our customer service department (p. 35).

#### **NOTICE**



#### **Heating up of the V-273 during operation!**

The heat produced during operation of the V-273 can affect your application.

- Ensure sufficient ventilation at the place of installation.
- Ensure that the average continuous current and the peak current do **not** exceed the permissible values (p. 37).

**NOTICE****Attraction of magnetizable objects!**

The magnets in the V-273 can attract magnetizable objects such as loose screws. Objects attracted can damage the V-273.

- Make sure that there are no movable, magnetizable objects within a radius of at least 10 cm around the housing of the V-273.
- Apply corresponding precautions also for storage and transport of the V-273.

**NOTICE****Damage to magnetically sensitive objects!**

The magnets in the V-273 can damage magnetically sensitive objects such as magnetic data carriers and electronic devices.

- Make sure that there are no magnetically sensitive objects within a radius of at least 10 cm around the housing of the V-273.
- Apply corresponding precautions also for storage and transport of the V-273.

**NOTICE****Operating voltage too high or incorrectly connected!**

Operating voltages that are too high or incorrectly connected can cause damage to the V-273.

- Operate the V-273 only with controllers/drivers and original accessories from PI.
- Do **not** exceed the operating voltage range (p. 38) for which the V-273 is specified.
- Operate the V-273 only when the operating voltage is properly connected; see "Pin Assignment" (p. 43).

**NOTICE****Undesired displacement due to lack of self-locking!**

The drive of the V-273 does not have self-locking. Switching off or rebooting the controller or switching off the servo mode for the axis can therefore lead to undesired displacements of the runner, e.g., due to the weight force of the moving mass. As a result, the runner can move to the hard stop with a high velocity, and/or collisions between the V-273, the load to be moved and the surroundings are possible.

- When the motion axis is aligned vertically or tilted: Perform an AutoZero procedure for the axis on the controller so that the weight force of the moving mass is also compensated for when the servo mode is switched off. For details, see the user manual of the C-413.
- Before switching off or rebooting the controller, take suitable measures to ensure that no unintentional motion of the runner is possible.
- Make sure that no collisions are possible between the linear actuator, the load to be moved, and the surroundings in the motion range of the linear actuator.
- Ensure that the end of the travel range is approached at low velocity and with low force.

**NOTICE****Damage due to collisions!**

Collisions can damage the linear actuator, the load to be moved, and the surroundings.

- Make sure that no collisions are possible between the linear actuator, the load to be moved, and the surroundings in the motion range of the linear actuator.
- Do not place any objects in areas where they can be caught by moving parts.
- Stop the motion immediately if a controller malfunction occurs.
- If possible, adapt the travel range limits of your mechanical system in the software that you use for commanding the motion.

**NOTICE****Damage due to high velocity and travel to the hard stop with maximum force!**

Travel to the hard stop with maximum force or at high velocity can cause damage, excessive heat or considerable wear to the mechanics.

- Stop the motion immediately if a controller malfunction occurs.
- Ensure that the end of the travel range is approached at low velocity and with low force.
- Set the control signal so that the moving part does not stop abruptly or try to continue moving at the end of the travel range.
- Determine the maximum velocity for your application.

**NOTICE****Damage to the V-273 and the load due to oscillation**

The optimum values of the servo control parameters of the controller depend on the application and the moved mass. Unsuitable servo control parameter settings of the controller can cause the V-273 to oscillate. Oscillation can damage the V-273 and/or the load affixed to it.

- If the V-273 is oscillating (unusual operating noise), immediately switch off the servo mode for the axis on the controller or switch off the controller.
- Only switch on the servo mode for the axis on the controller after you have modified the servo control parameter settings; see the manual of the controller.

**NOTICE****Damage from transport safeguard that has not been removed!**

Damage can occur to the linear actuator if the transport safeguard (p. 15) of the linear actuator has not been removed and a motion is commanded.

- Remove the transport safeguard before you start up the system consisting of the linear actuator and the controller.

**INFORMATION**

The C-413 controller and the V-273 are delivered as a preconfigured system.

- If a connection assignment is given on the labels of the controller and/or V-273, observe this assignment when connecting the V-273.

**INFORMATION**

The C-413 controller sets the control value of the axis to the value of the AutoZeroResult parameter (ID 0x07000A03) when the servo mode is switched off.

After an AutoZero procedure has been successfully performed, the parameter value is set so that the V-273 compensates for the weight force of the moving mass with the corresponding control value (important with a vertically aligned motion axis).

Further information can be found in the user manual of the C-413 controller.

**INFORMATION**

The repeatability of the positioning is only ensured when the reference switch is always approached from the same side. Recommended controllers from PI fulfill this requirement with their automatic direction detection for reference moves to the reference switch.

**INFORMATION**

The force sensor of the V-273.441 model works as an incremental sensor. When the controller is switched on or rebooted, the connected force sensor always measures 0 N, regardless of the actual force exerted on the force sensor.

- In order to allow absolute force measurement, ensure that **no** force acts on the contact part of the force sensor when the controller is switched on or rebooted.

## 6.2 Temperature Dependency of the Nominal Current: Calculating the Nominal Current

The nominal current in the data table (p. 37) only applies when operating at room temperature. The nominal current needed for operating the actuator must be adjusted when the ambient temperature rises.



### Calculating the nominal current

- Calculate the nominal current according to the ambient temperature as follows:

$$I(T) = I(T_{\text{ref}}) \cdot \sqrt{\frac{T_{\text{max}} - T}{T_{\text{max}} - T_{\text{ref}}}}$$

With:

$I(T)$  = Nominal current, depending on ambient temperature  $T$

$T$  = Ambient temperature

$I(T_{\text{ref}})$  = Nominal current, determined at reference temperature  $T_{\text{ref}}$ , see specifications

$T_{\text{ref}}$  = Reference temperature (22 °C)

$T_{\text{max}}$  = Maximum temperature of actuator components, see specifications

## 6.3 Starting Up the V-273 with the C-413 Controller

### NOTICE



#### Unexpected motion!

The V-273 can perform unexpected motion after the controller is switched on or rebooted. Unexpected motion can lead to damage due to collisions.

- **Before** connecting the V-273, check whether the controller is configured for automatic execution of the reference move or the autozero procedure; see user manual of the controller.

### INFORMATION

The type of the connection on the C-413 controller and the parameter settings of the C-413 determine the identifiers that are to be used to command the V-273. Assignment with the default settings of the C-413 controller:

- Motor cable connected to the **Motor & Sensor 1** socket using the V901B0030 adapter and - if present - force sensor connected to the **Motor & Sensor 2** socket: V-273 is commanded as axis 1; the force sensor can be read out as input signal channel 3 and must be assigned to axis 1 via the Input Channel for Force Feedback parameter (ID 0x07000400).
- Motor cable connected to the **Motor & Sensor 2** socket using the V901B0030 adapter and - if present - force sensor connected to the **Motor & Sensor 1** socket: V-273 is commanded as axis 2; the force sensor can be read out as input signal channel 1 and must be assigned to axis 2 via the Input Channel for Force Feedback parameter (ID 0x07000400).

### Requirements

- ✓ You have read and understood the general notes on startup and operation (p. 25).

- ✓ You have read and understood the user manual of the controller.
- ✓ You have read and understood the manual of the PC software.
- ✓ You have properly installed the linear actuator (p. 17).
- ✓ The controller and the required PC software have been installed.
- ✓ All connections to the controller have been made (see user manual of the controller; the linear actuator is connected via the V901B0030 adapter, the motor cable and additionally, for the V-273.441, via the cable of the force sensor).
- ✓ You have installed the linear actuator so that no force is applied to the contact part of the force sensor when the controller is switched on or rebooted (p. 20).

### Starting up the V-273 with the C-413 controller

- Start up the axis (see C-413 user manual).  
The startup involves the following steps:
  - Defining the reference point of the axis
  - Optional: AutoZero procedure for the axis
  - Optional: Selection of the closed-loop control mode
  - Commanding initial motion in closed-loop operation for testing the mechanical system

In the user manual of the C-413 controller, the startup is described using the PIMikroMove program.

## 7 Maintenance

### In this Chapter

General Notes on Maintenance.....	31
Preparing the V-273 for Transport.....	31
Cleaning the V-273.....	32

### 7.1 General Notes on Maintenance

#### NOTICE



#### Damage from opening the V-273!

The V-273 is maintenance-free. Opening the housing causes damage to the V-273.

- Only loosen screws according to the instructions in this manual.
- Do **not** open the V-273.

### 7.2 Preparing the V-273 for Transport

#### NOTICE



#### Mechanical overload from incorrect handling!

An impermissible mechanical load on the V-273 due to transportation without a transport safeguard and incorrect handling, can damage the runner of the V-273 as well as cause loss of accuracy.

- Only ship the V-273 in the original packaging and with the transport safeguard attached.
- Only hold the V-273 by the housing

#### Tools and accessories

- Transport safeguard (bracket with 2 M3x8 screws) (p. 7)
- Hex key AF 2.5

#### Preparing the V-273 for transport

- Attach the transport safeguard to the housing and runner (p. 7) using two M3 screws.

## 7.3 Cleaning the V-273

### Requirements

- ✓ You have disconnected the linear actuator from the controller.

### Cleaning the linear actuator

- When necessary, clean the surface of the linear actuator with a cloth dampened lightly with a mild cleanser or disinfectant.

## 8 Troubleshooting

Problem	Possible causes	Solution
Target position is approached too slowly or with overshoot	<ul style="list-style-type: none"> <li>▪ Servo control parameters are not optimally set</li> <li>▪ Large changes to the load or the alignment of the V-273</li> <li>▪ Velocity / acceleration set improperly</li> </ul>	<ul style="list-style-type: none"> <li>➤ Switch off the servo control system or the controller immediately.</li> <li>➤ Check whether the servo control parameter settings correspond to the selected closed-loop control mode; see user manual of the controller.</li> <li>➤ If necessary, correct the settings of the servo control parameters.</li> </ul>
Target position is not kept stable		
Uncontrolled oscillation of the V-273		
Increased wear	<ul style="list-style-type: none"> <li>▪ Warped housing</li> <li>▪ Excessive lateral forces on the runner</li> <li>▪ Velocity too high</li> <li>▪ Travel with maximum force to the hard stop</li> </ul>	<ul style="list-style-type: none"> <li>➤ Mount the V-273 on an even surface. The recommended flatness of the surface is 20 µm.</li> <li>➤ Ensure that the end of the travel range is approached at low velocity and with low force.</li> </ul>
Reduced accuracy		
No or limited motion	<ul style="list-style-type: none"> <li>▪ Excessive load</li> <li>▪ Excessive counterforces in the direction of motion</li> <li>▪ Transport safeguard has not been removed</li> <li>▪ After operation without the adapter: The V-273 and/or the controller are damaged.</li> </ul>	<ul style="list-style-type: none"> <li>➤ Reduce the load and/or counterforces in the direction of motion.</li> <li>➤ Remove the transport safeguard.</li> <li>➤ Contact our customer service department (p. 35).</li> </ul>

If the problem that occurred with your system is not listed in the table above or cannot be solved as described, contact our customer service department (p. 35).



## 9 Customer Service

For inquiries and orders, contact your PI sales engineer or send us an email ([service@pi.de](mailto:service@pi.de)).

- If you have any questions concerning your system, provide the following information:
  - Product and serial numbers of all products in the system
  - Firmware version of the controller (if applicable)
  - Version of the driver or the software (if applicable)
  - Operating system on the PC (if applicable)
- If possible: Take photographs or make videos of your system that can be sent to our customer service department if requested.

The latest versions of the user manuals are available for download (p. 3) on our website.





## 10 Technical Data

### In this Chapter

Specifications .....	37
Dimensions .....	40
Pin Assignment .....	43

### 10.1 Specifications

#### 10.1.1 Data Table

	V-273.440 V-273.441	Unit	Tolerance
Active axes	Z		
<b>Motion and positioning</b>			
Travel range	20	mm	
Integrated sensor	Optical linear encoder		
Sensor resolution	10 <sup>(1)</sup>	nm	max.
Minimum incremental motion	100	nm	typ.
Linearity error, closed loop	1	%	typ.
Repeatability	±0.5	µm	typ.
Velocity	100	mm/s	max.
Force sensor resolution (optional)	1	mN	max.
Smallest force step (optional)	5	mN	typ.
<b>Mechanical properties</b>			
Bearing / guide	Recirculating ball bearing guide		
Motion straightness	±20	µm	±5 %
Moved mass without load	100 (230 with force sensor)	g	typ.
<b>Drive properties</b>			
Motor type	PIMag® Voice coil drive, moving coil		
Coil resistance	16	Ω	typ., at 20°C
Coil inductance	6	mH	typ., at 20°C

	V-273.440 V-273.441	Unit	Tolerance
Time constant	0.375	ms	
Back EMF	8	V-s/m	
Force constant	8	N/A	typ.
Motor constant	2	N/(√W)	
Current constant	0.125	A/N	typ.
Nominal current	375 <sup>(2)</sup>	mA	max.
Peak current (max. 3 s)	800	mA	
Average push/pull force	3	N	nominal
Power dissipation of the coil with 100 % duty cycle	2.25	W	
Maximum push/pull force	6	N	max.
Permitted temperature for actuator components	60	°C	max.
<b>Miscellaneous</b>			
Operating temperature range	10 to 60	°C	
Material	Aluminum		
Mass	660 (790 with force sensor)	g	±5 %
Cable length	Motor / sensor cable: 1.5 V-273.441: Force sensor cable: 1	m	
Motor / sensor connector	D-sub 15 (m) with force sensor: 2 × D-sub 15 (m)		
Lifetime	>10 <sup>7</sup>	cycles	min.
Recommended controller	C-413.2x		

(1) With C-413 controller.

(2) Do not exceed for continuous operation.

The specifications apply to room temperature (22 °C ±3 °C), specifications may deviate outside of this range.

### 10.1.2 Maximum Ratings

The voice coil drive of the V-273 linear actuator is designed for the following operating data:

Maximum Operating Voltage	Maximum Operating Frequency	Maximum Power Consumption
48 V	---	24 W

### 10.1.3 Ambient Conditions and Classifications

The following ambient conditions and classifications for the V-273 must be observed:

Area of application	For indoor use only
Maximum altitude	2000 m
Air pressure	1100 hPa to 795 hPa (corresponds to roughly 825 Torr to 596 Torr)
Relative humidity	Highest relative humidity 80% for temperatures up to 31 °C Decreasing linearly to 50% relative humidity at 40 °C
Storage temperature	-20 °C to 60 °C
Transport temperature	-20 °C to 60 °C
Overvoltage category	II
Protection class	I
Degree of pollution	1
Degree of protection according to IEC 60529	IP20

### 10.1.4 Reference Switch Specifications

Type	Optical sensor
Supply voltage	+5 V / GND, supply via the motor connector
Signal output	TTL level
Signal logic	Direction sensing by means of different signal levels on the left- and right-hand side of the reference switch: The signal level changes from 0 to +5 V when the reference switch is passed.

## 10.2 Dimensions

### 10.2.1 V-273.440

Dimensions in mm. Note that a comma is used in the drawings instead of a decimal point.

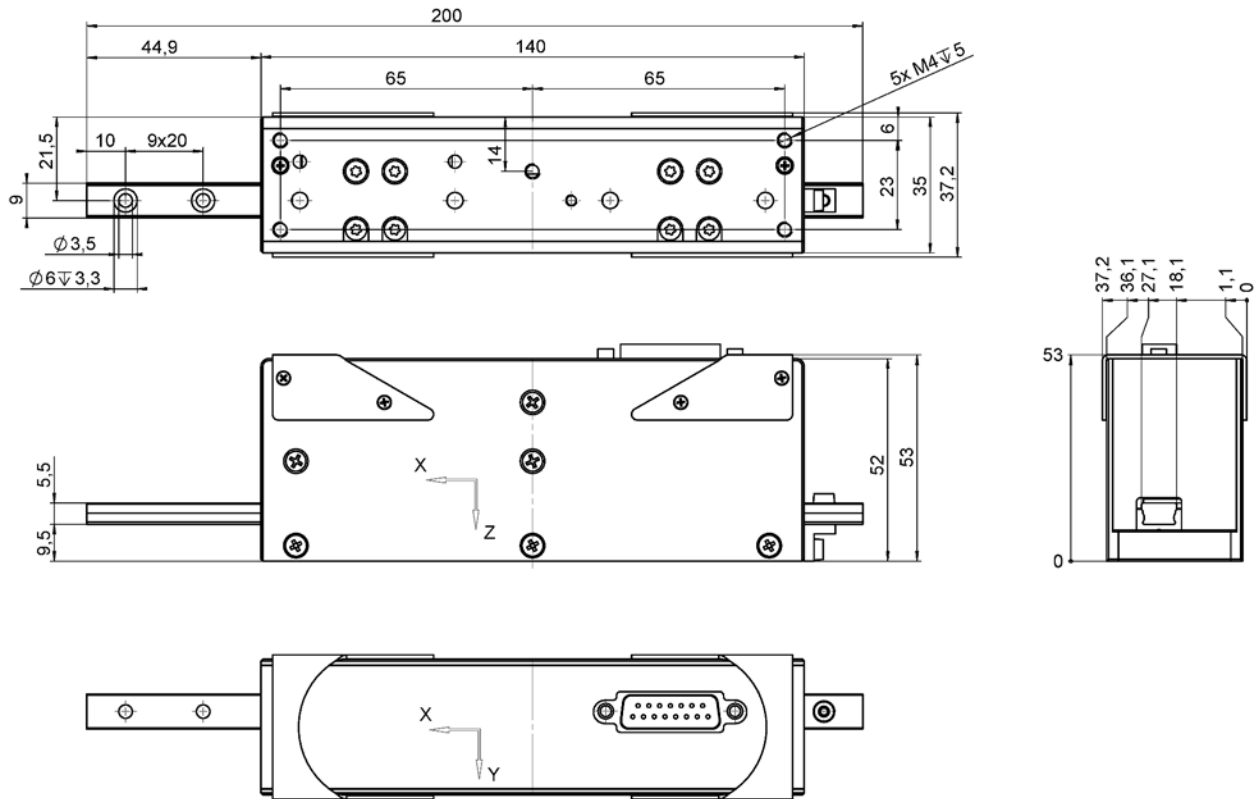

Figure 12: Dimensions of the V-273.440, runner in reference position

### 10.2.2 V-273.441

Dimensions in mm. Note that a comma is used in the drawings instead of a decimal point.

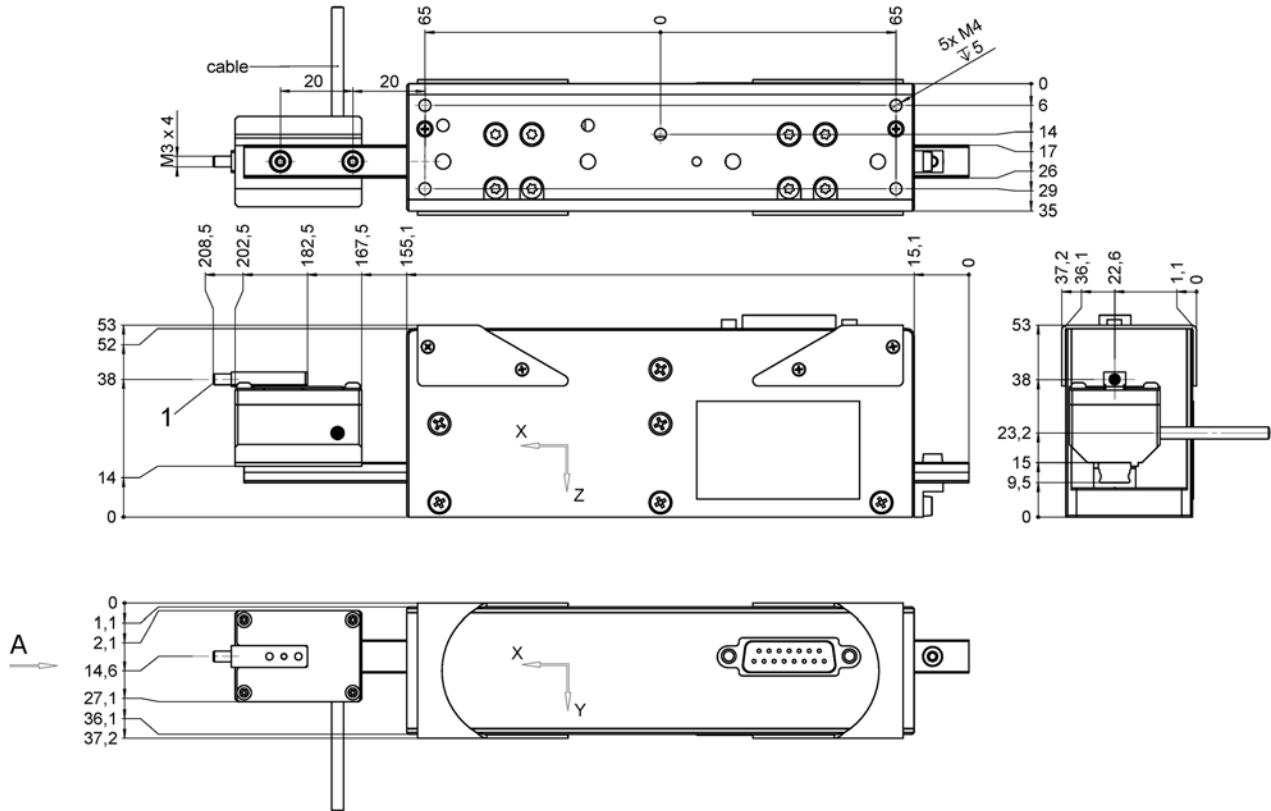

Figure 13: Dimensions of the V-273.441, here without contact part of the force sensor; runner in reference position

1 M3 external thread

A shows the ideal direction of a force acting on the force sensor

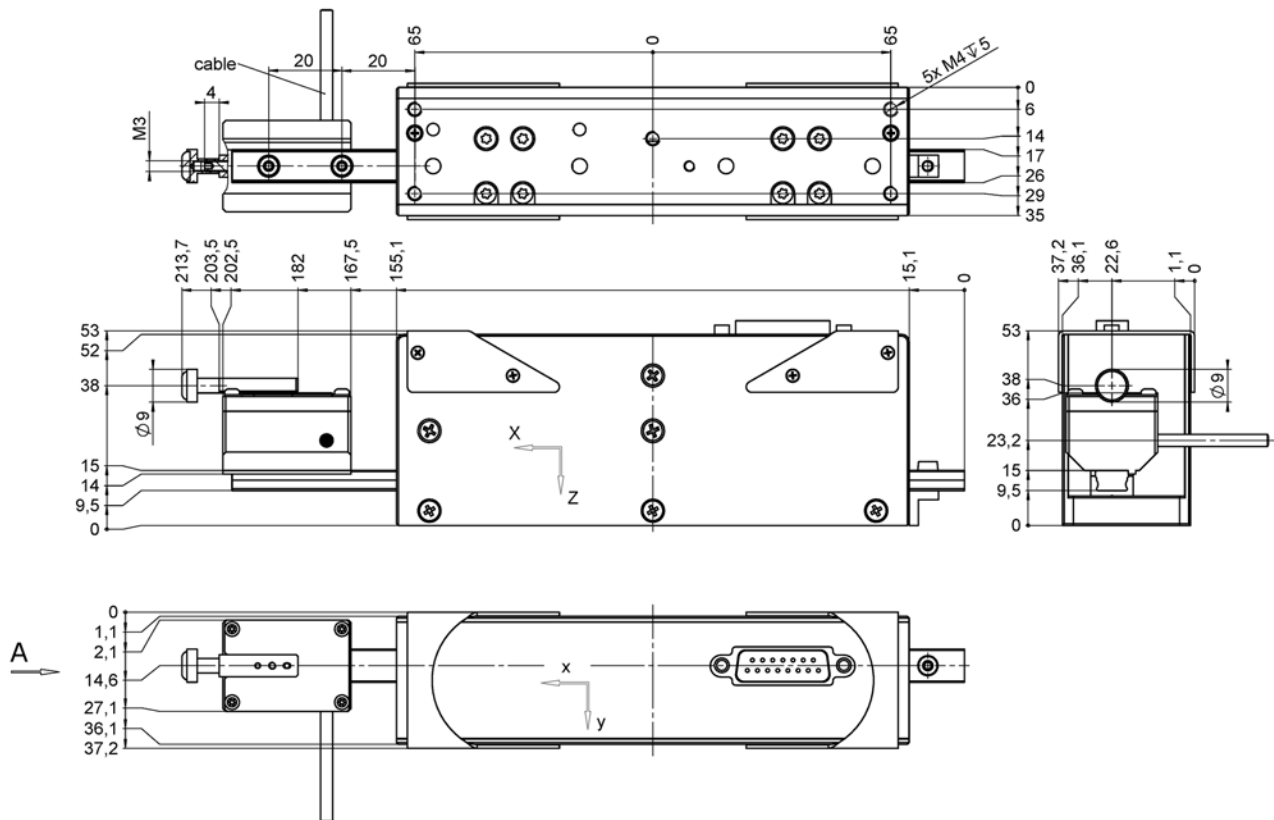

Figure 14: Dimensions of the V-273.441, here with contact part of the force sensor; runner in reference position

## 10.3 Pin Assignment

### 10.3.1 Motor and Position Sensor Connector

#### D-sub 15 (m) panel plug

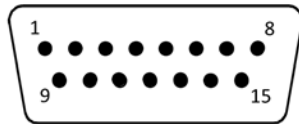

Figure 15: Sub-D 15 (m) panel plug

Pin	Function*	Direction
1	Reference (-)	TTL output
2	Motor (-)	Input current
3	AGND	GND
4	VDD, +5 V	Input
5	-	-
6	-	-
7	SIN (-)	TTL output
8	COS (-)	TTL output
9	Motor (+)	Input current
10	AGND	GND
11	AGND	GND
12	-	-
13	Reference (+)	TTL output
14	SIN (+)	TTL output
15	COS (+)	TTL output

\* The "-" sign indicates that the corresponding pin has not been assigned.

### 10.3.2 V901B0030 Adapter

#### Sub-D 15 (m/f)

Connector side for connection to the controller

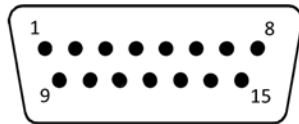

Figure 16: Sub-D 15 (m) connector

Socket side for connection to the actuator

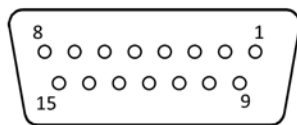

Figure 17: Sub-D 15 (f) socket

Actuator side		Controller side	
Pin	Signal	Pin	Signal
1	Reference (-)	1	-
2	Motor (-)	2	Motor (-)
3	AGND	3	AGND
4	VDD, +5V	4	VDD, +5V
5	-	5	-
6	-	6	CS_EEPROM_1
7	SIN (-)	7	SPI_MOSI
8	COS (-)	8	SPI_MISO
9	Motor (+)	9	Motor (+)
10	AGND	10	AGND
11	AGND	11	AGND
12	-	12	-
13	Reference (+)	13	Reference
14	SIN (+)	14	SPI_CLK
15	COS (+)	15	TW8_CS_1

\* The "-" sign indicates that the corresponding pin has not been assigned.



### 10.3.3 V-273.441: Force Sensor Connector

#### Sub-D 15 connector (m)

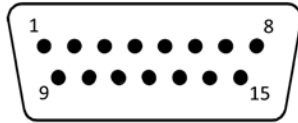

Figure 18: Sub-D 15 (m) connector

Pin	Function*	Direction
1	-	-
2	-	-
3	GND	GND
4	VDD, + 5 V	Input
5	-	-
6	SPI_CS_EEPROM	TTL input
7	SPI_MOSI	TTL input
8	SPI_MISO	TTL output
9	-	-
10	-	-
11	-	-
12	-	-
13	-	-
14	SPI_CLK	TTL input
15	SPI_CS_SENSOR	TTL input

\* The "-" sign indicates that the corresponding pin has not been assigned.



## 11 Old Equipment Disposal

In accordance with EU law, electrical and electronic equipment may not be disposed of in EU member states via the municipal residual waste.

Dispose of your old equipment according to international, national, and local rules and regulations.

In order to fulfil its responsibility as the product manufacturer, Physik Instrumente (PI) GmbH & Co. KG undertakes environmentally correct disposal of all old PI equipment made available on the market after 13 August 2005 without charge.

Any old PI equipment can be sent free of charge to the following address:

Physik Instrumente (PI) GmbH & Co. KG  
Auf der Roemerstr. 1  
D-76228 Karlsruhe, Germany





## 12 EU Declaration of Conformity

For the V-273, an EU Declaration of Conformity has been issued in accordance with the following European directives:

EMC Directive

RoHS Directive

The applied standards certifying the conformity are listed below.

EMC: EN 61326-1

Safety: EN 61010-1

RoHS: EN 50581

